

Instituto Federal de Educação, Ciência e Tecnologia de Santa Catarina

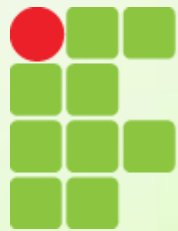

**INSTITUTO FEDERAL
SANTA CATARINA**

**Departamento Acadêmico de Eletrônica
Eletrônica Básica e Projetos Eletrônicos**

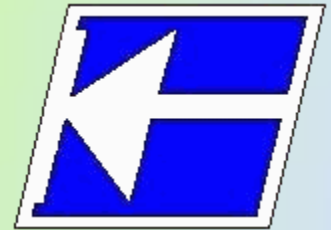

Transistores Bipolares de Junção

Prof. Clóvis Antônio Petry.

Florianópolis, abril de 2009.

Nesta aula

Seqüência de conteúdos:

1. Introdução;
2. Construção dos transistores;
3. Operação dos transistores;
4. Configuração emissor comum;
5. Polarização;
6. Limites de operação;
7. Transistores Darlington;
8. Encapsulamento de transistores;
9. Principais características de catálogo;
10. Tipos de transistores.

Bibliografia

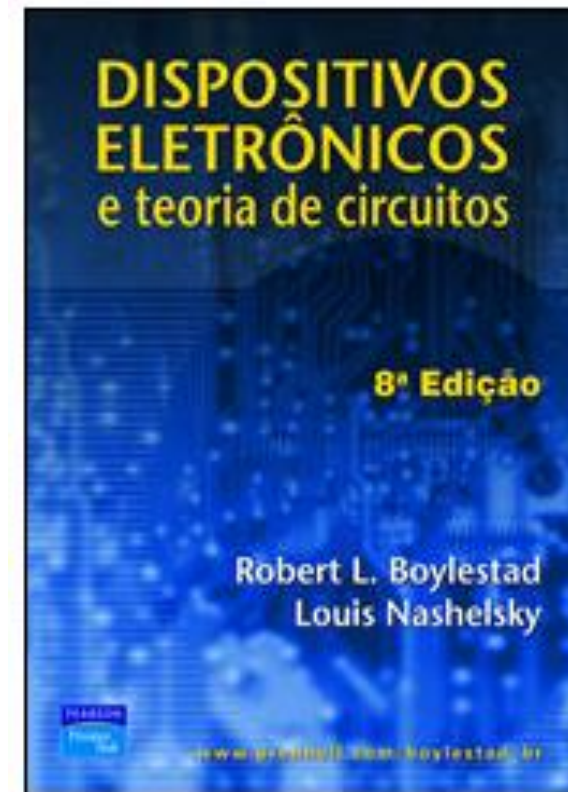
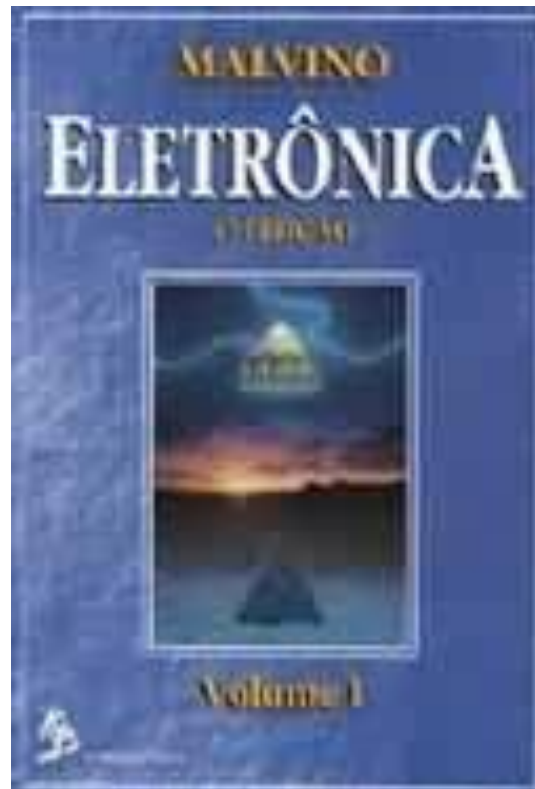

Introdução

Histórico:

- Diodo a válvula – 1904 por J. A. Fleming;
- Triodo a válvula – 1906 por Lee De Forest;
- Transistor – 1947 por Walter H. Brattain e John Bardeen.
- Posteriormente: Mosfet, Igbt, Silicon Carbide, etc.

Do Transistor ao Microprocessador

Ewildo L. M. Mehl

I. Válvulas sem vácuo

Nos primórdios da eletrônica tinham-se duas possibilidades para retificar uma corrente alternada: uma delas era usando-se uma válvula-diodo e outra, empregando diodos de óxido de cobre ou óxido de selênio. Porém, colocados numa grade metálica entre o cátodo e o ânodo de uma válvula diodo, tem-se uma nova espécie de válvula, chamada triodo, com a qual é possível controlar o fluxo de corrente através do dispositivo. Desta forma, é óbvio que desde os primórdios da eletrônica tem-se tentado o desenvolvimento de um "modo sem vácuo", fazendo-se um paralelo entre as válvulas-diodos e os diodos de óxido de cobre e óxido de selênio. Nesse sentido durante a década de 1920 foram registradas diversas patentes de invenções de "modos selidos", porém sem que inventores dados originem dispositivos comerciais.

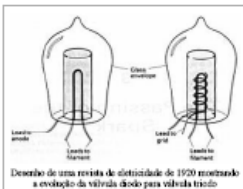

Desenho de uma revista de eletrônica de 1920 mostrando a evolução de uma válvula diodo para uma válvula triodo.

Frente a tais tentativas, é interessante que a invenção do transistor tenha sido sua origem em uma área de pesquisa relativamente distante, ligada ao desenvolvimento do radar. Ao contrário do que seria de se imaginar, o transistor surgiu como resultado de estudos onde se desejava usar cristais de germano e de silício como detectores de radar e não por uma finalidade puramente científica. Também é interessante observar que o transistor, ao contrário de outras descobertas, não é propriamente um "produto de guerra", mas uma invenção ocorrida imediatamente após a Segunda Guerra Mundial, como uma espécie de consequência da disponibilidade de cristais de germano altamente purificados produzidos como um subproduto.

A invenção do transistor está intimamente ligada a instituição onde ele "nasceu": o laboratório de pesquisas da empresa Bell Telephone, conhecido como Bell Labs. Assim não é coincidência que o primeiro personagem de importância para a história do transistor é justamente um engenheiro que trabalhou nesse centro de pesquisa desde a sua fundação até se aposentar. George Clark Southworth (1890-1972) nasceu no estado norte-americano da Pensilvânia e formou-se no Grove City College, onde fez também curso de Mestrado. Posteriormente na Yale University obteve seu título de Ph.D. No Bell Labs ele trabalhou com guias para microondas e dessa forma criou de forma direta no desenvolvimento do radar, durante a Segunda Guerra Mundial.



George Clark Southworth



Russel S. Ohl

Para verificar que as válvulas triodos funcionavam bem como detectores de ondas de rádio mas eram inúteis como detectores de radar, Southworth resolveu experimentar no radar os mesmos cristais que eram usados nos primeiros receptores de rádio. Esses rádios, chamados de "radio-galena" usavam como detector um pequeno pedaço de um minério cristalizado de chumbo e enxofre (PbS), conhecido pelos geólogos como galena. Tais receptores já se achavam ultrapassados nessa época e dessa forma Southworth teve que obter cristais de galena retirados de antigos receptores de rádio que encontraram em lojas de artigos de segunda-mão na cidade de Nova York.

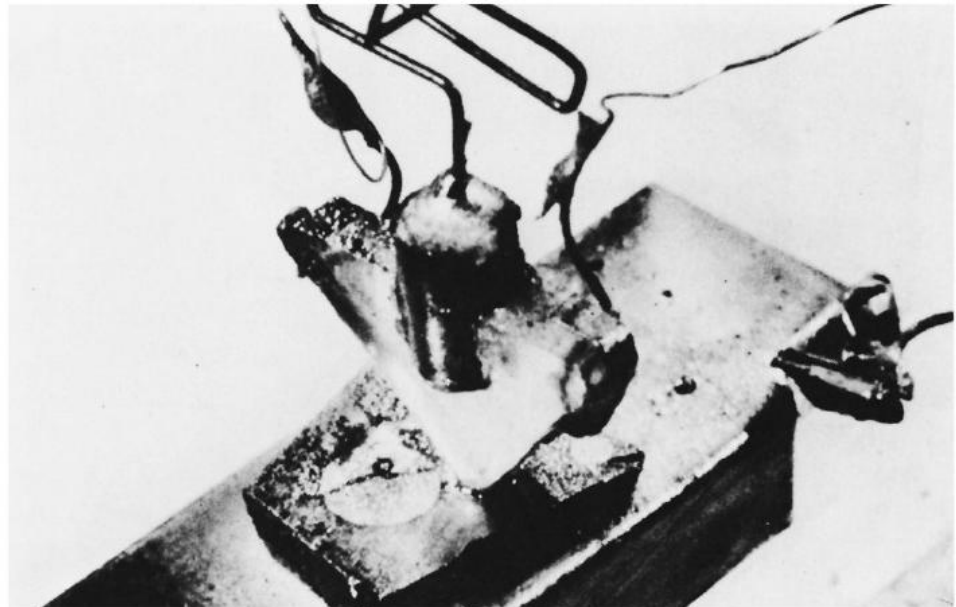

Introdução

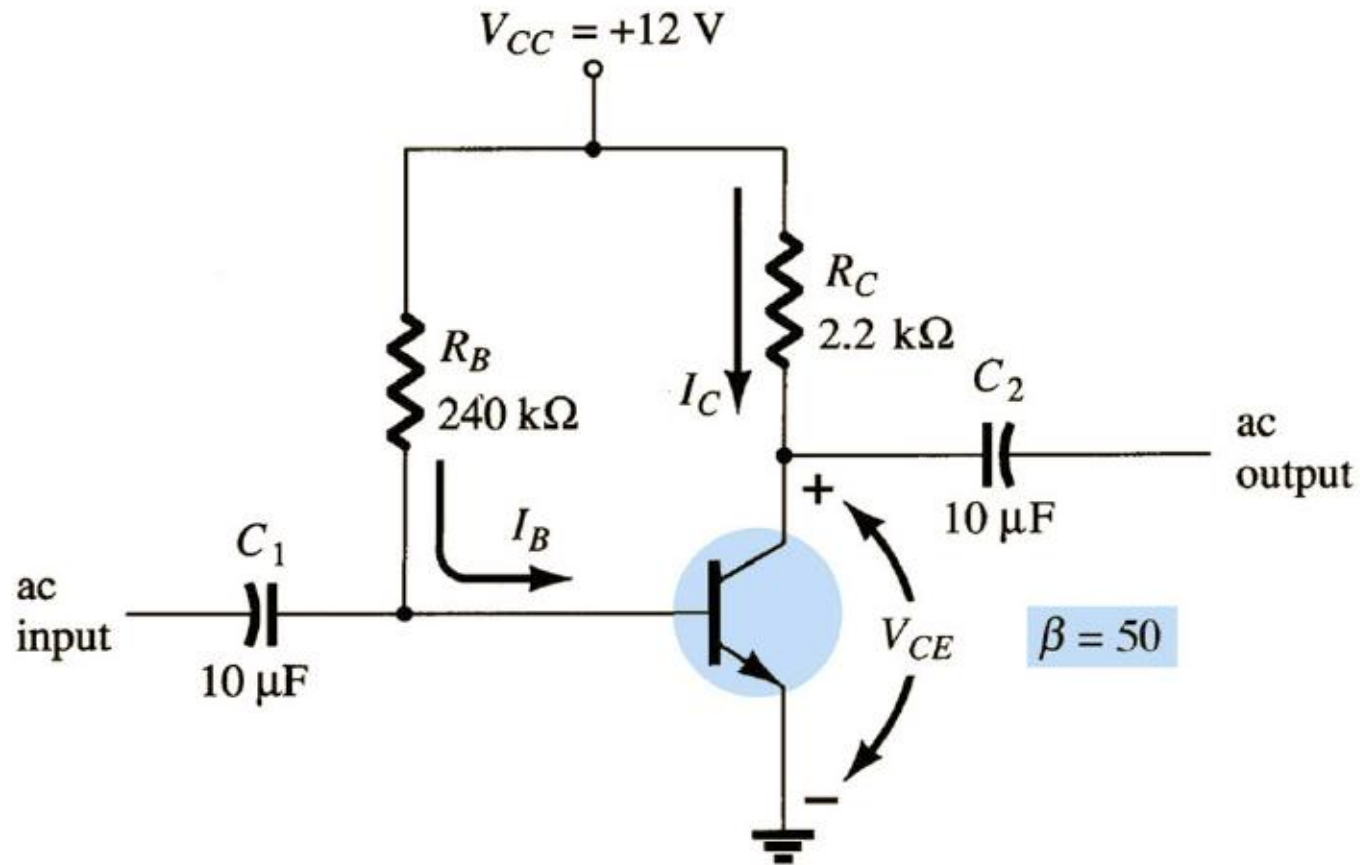

Amplificador com transistor bipolar.

Introdução

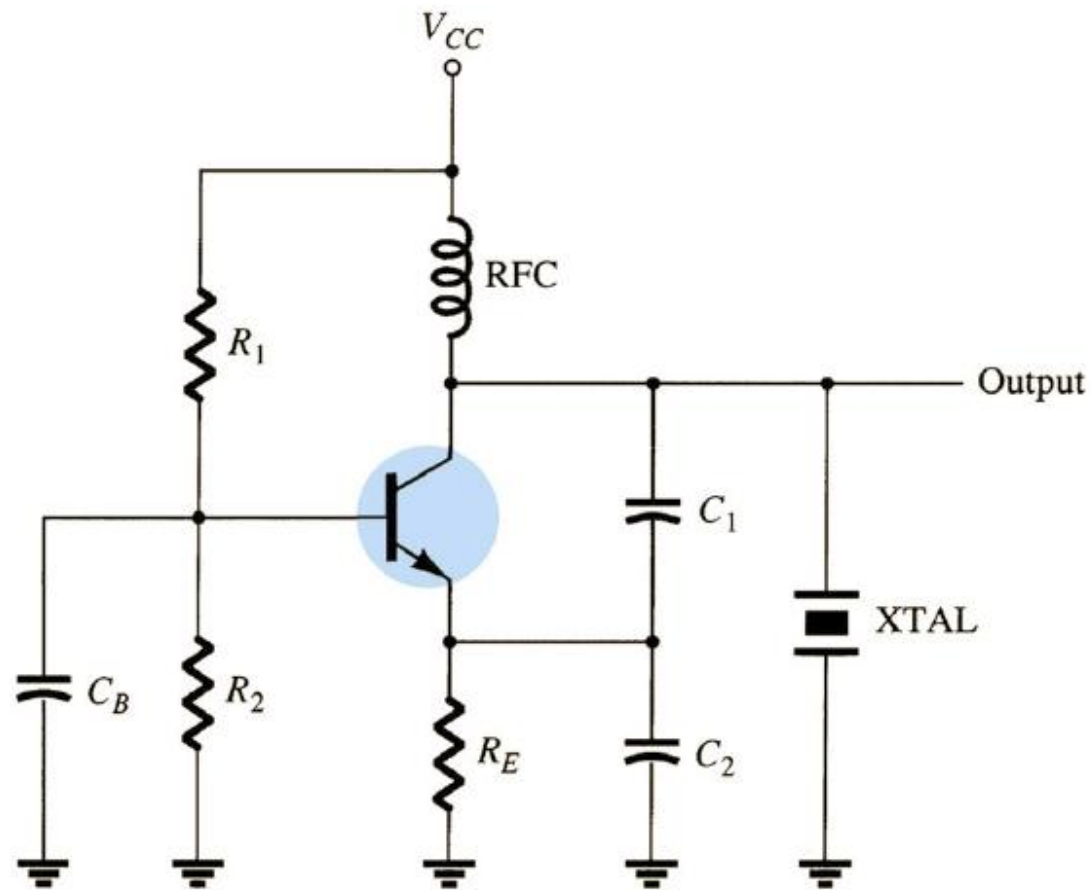

Oscilador controlado a cristal.

Introdução

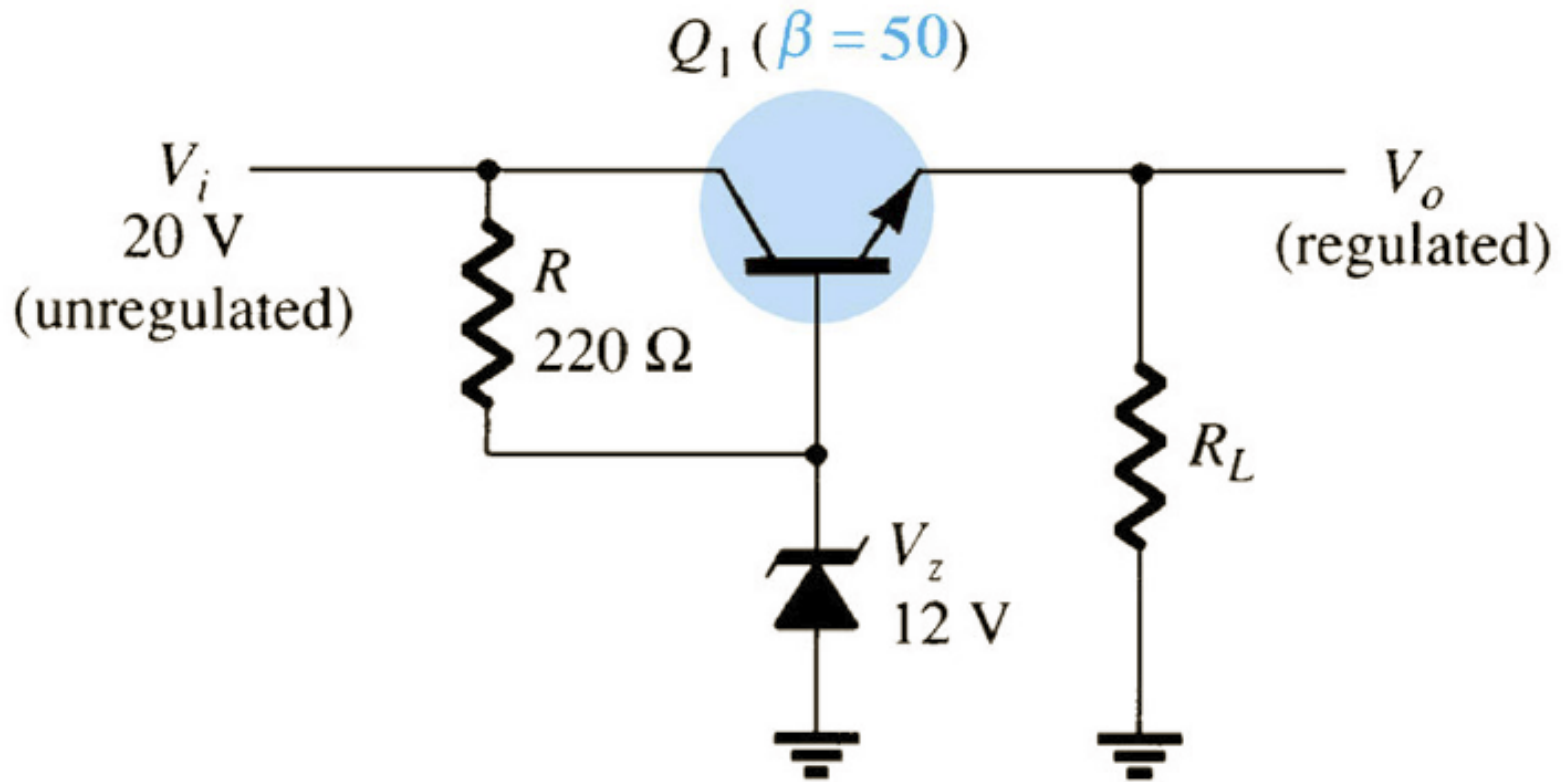

Regulador de tensão com transistor bipolar.

Construção do transistor

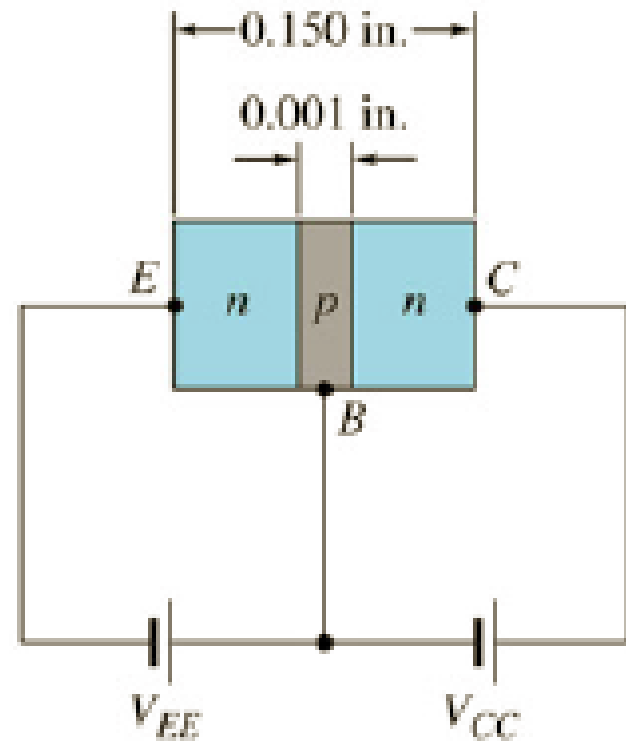
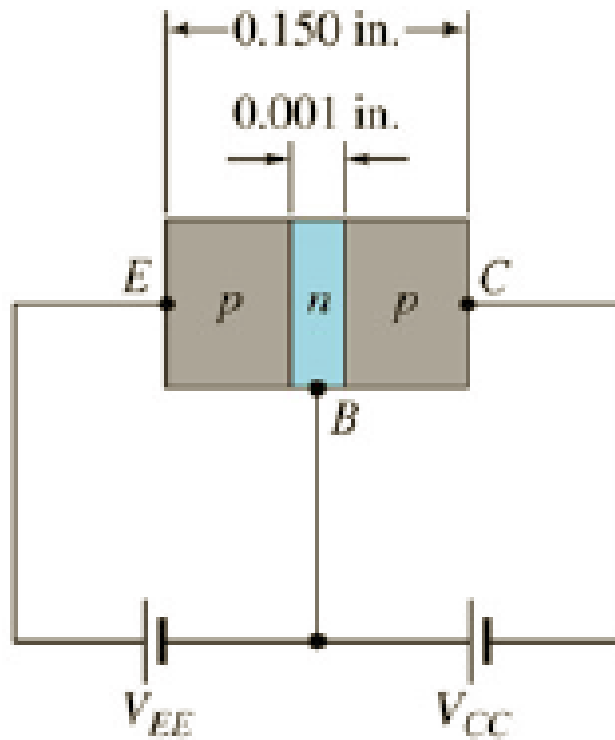

BJT – Transistor Bipolar de Junção: Lacunas e elétrons formam as correntes.

Construção do transistor

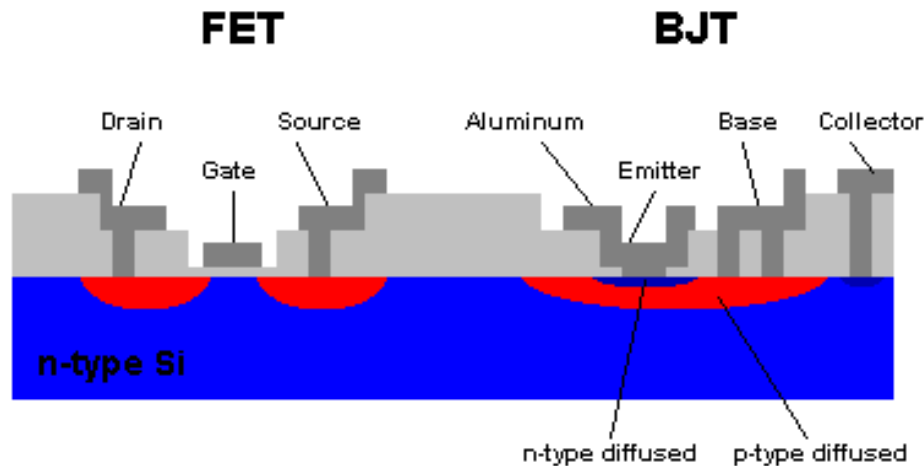

- p-type Si(diffused)
- n-type Si(substrate)
- SiO₂
- Aluminum
- Photoresist
- n-type Si(diffused)

The last step is to pattern aluminum into appropriate shapes. After annealing(baking) at 475 degrees Celcius to improve the aluminum contacts with the silicon, the devices are ready to be tested.

Navigation buttons: first, previous, next, last, animation_next

Operação do transistor

Relembrando os diodos:

$$V_D = 0V$$

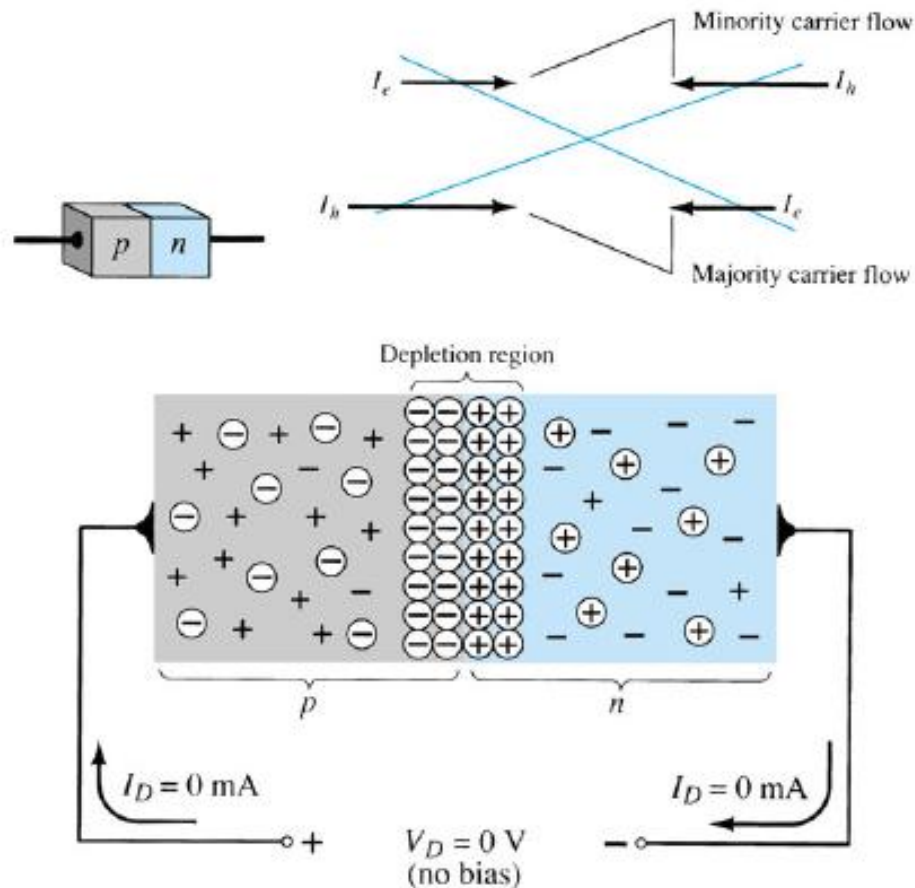

Operação do transistor

Relembrando os diodos:

$$V_D < 0V$$

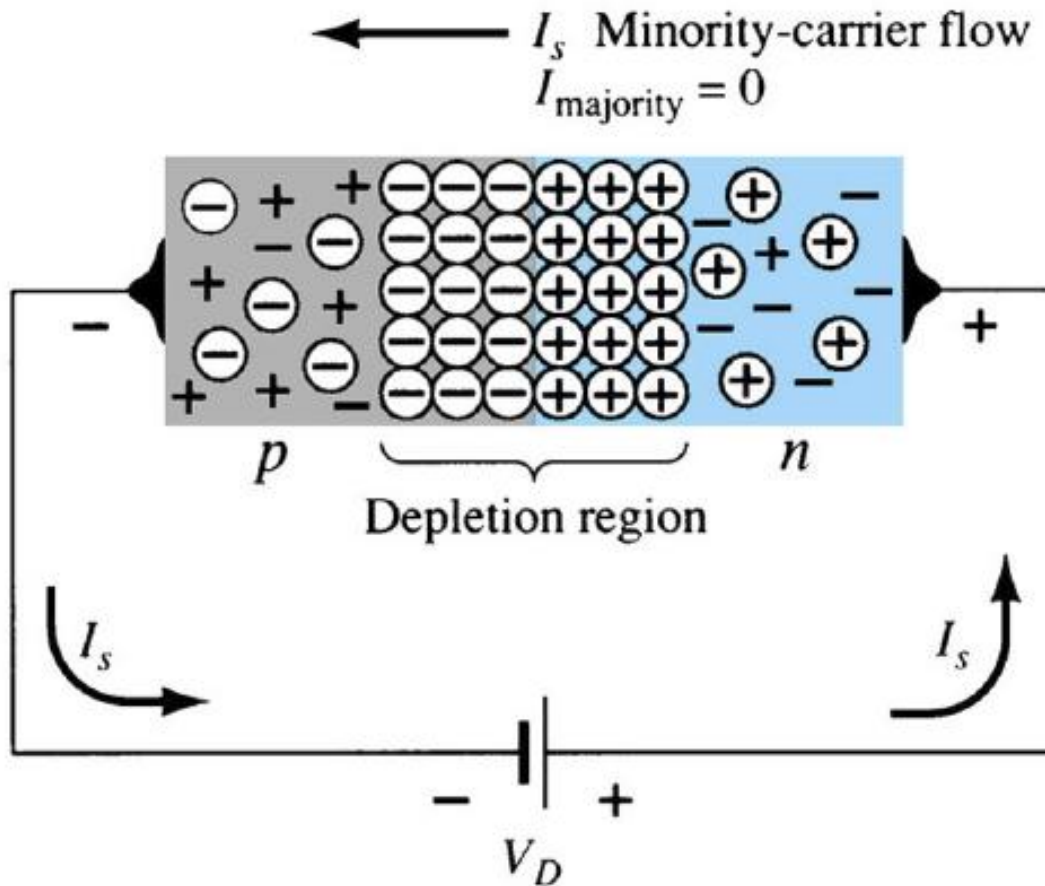

Operação do transistor

Relembrando os diodos:

$$V_D > 0V$$

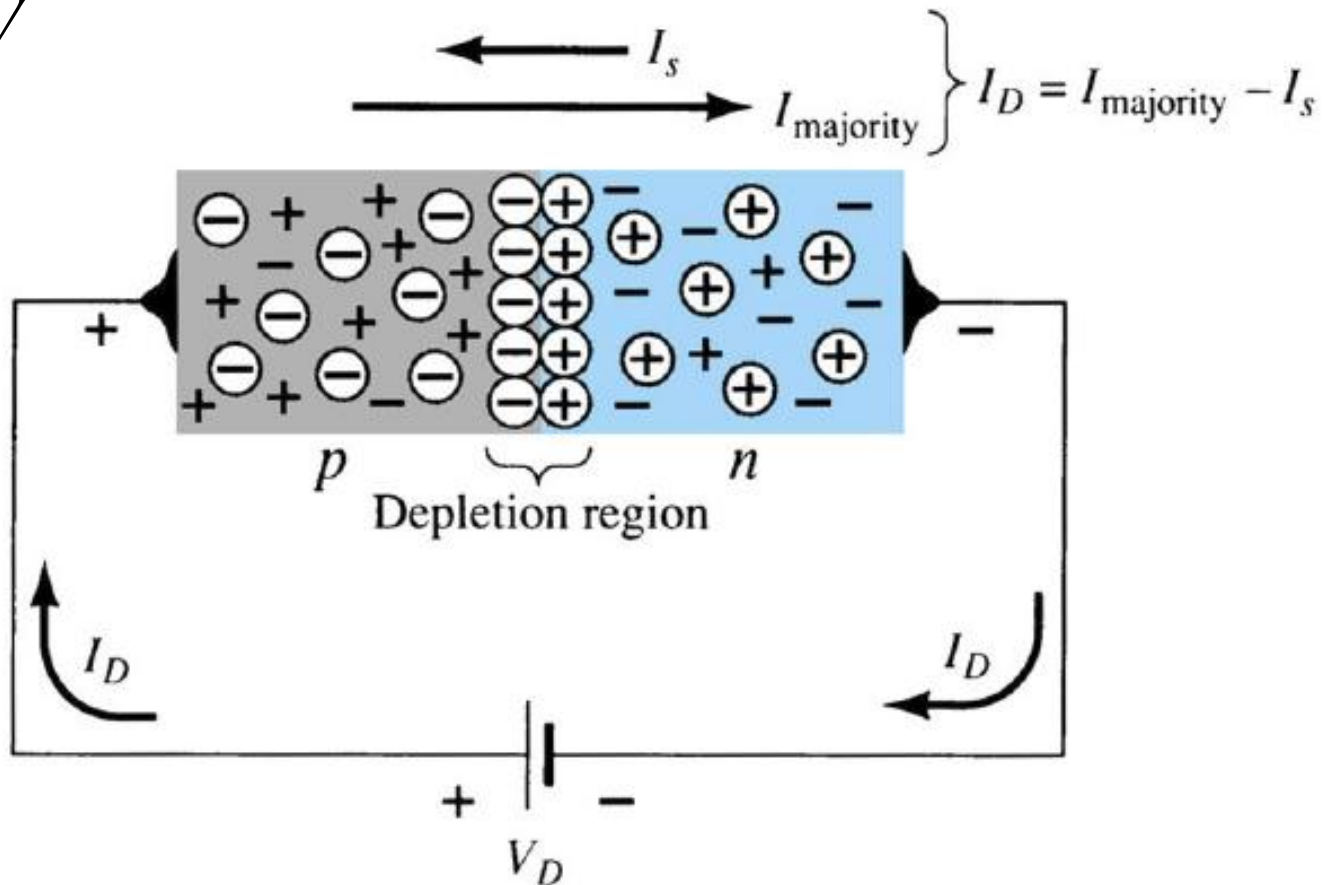

Operação do transistor

Transistor PNP:

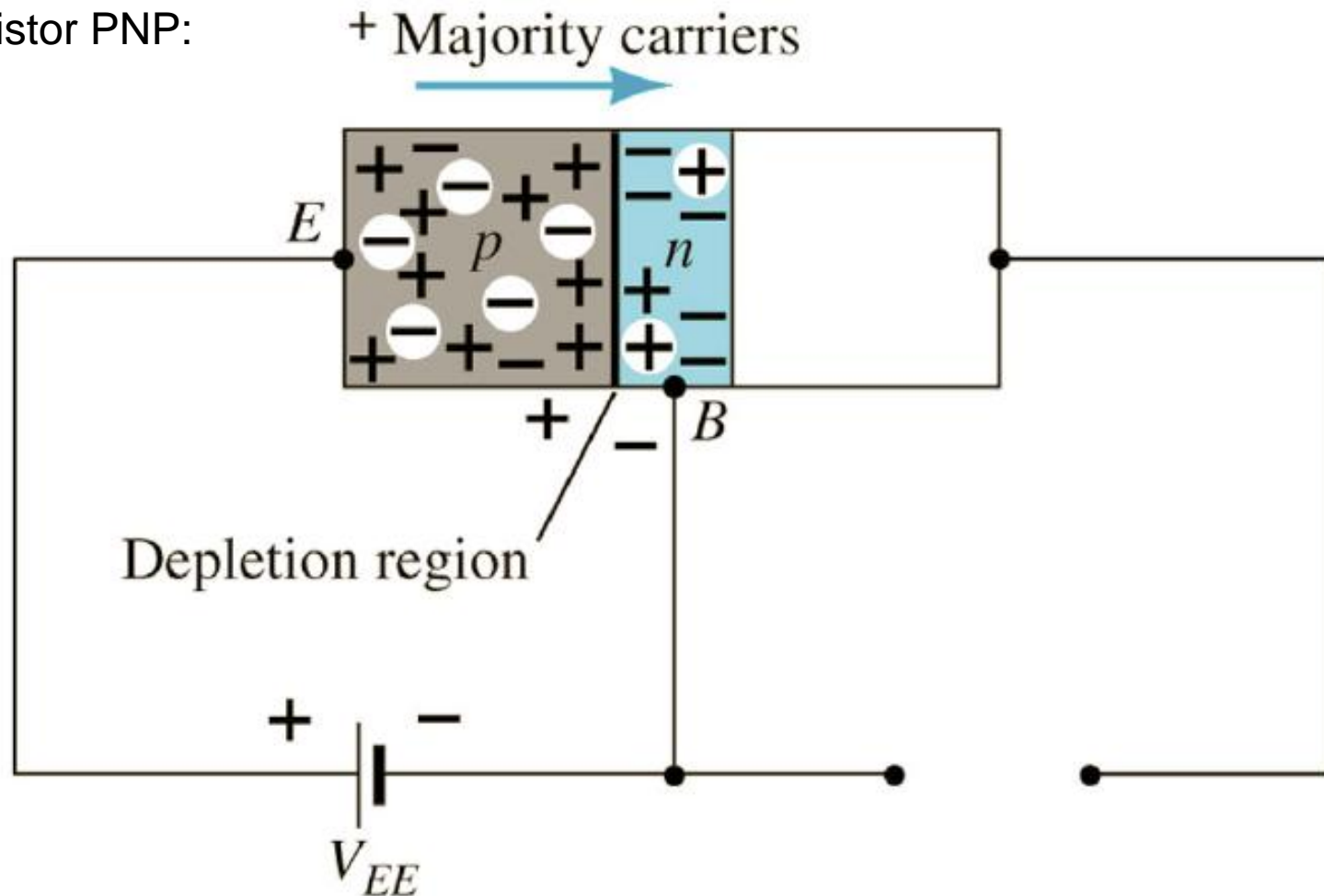

Junção Base – emissor polarizada diretamente.

Operação do transistor

Transistor PNP:

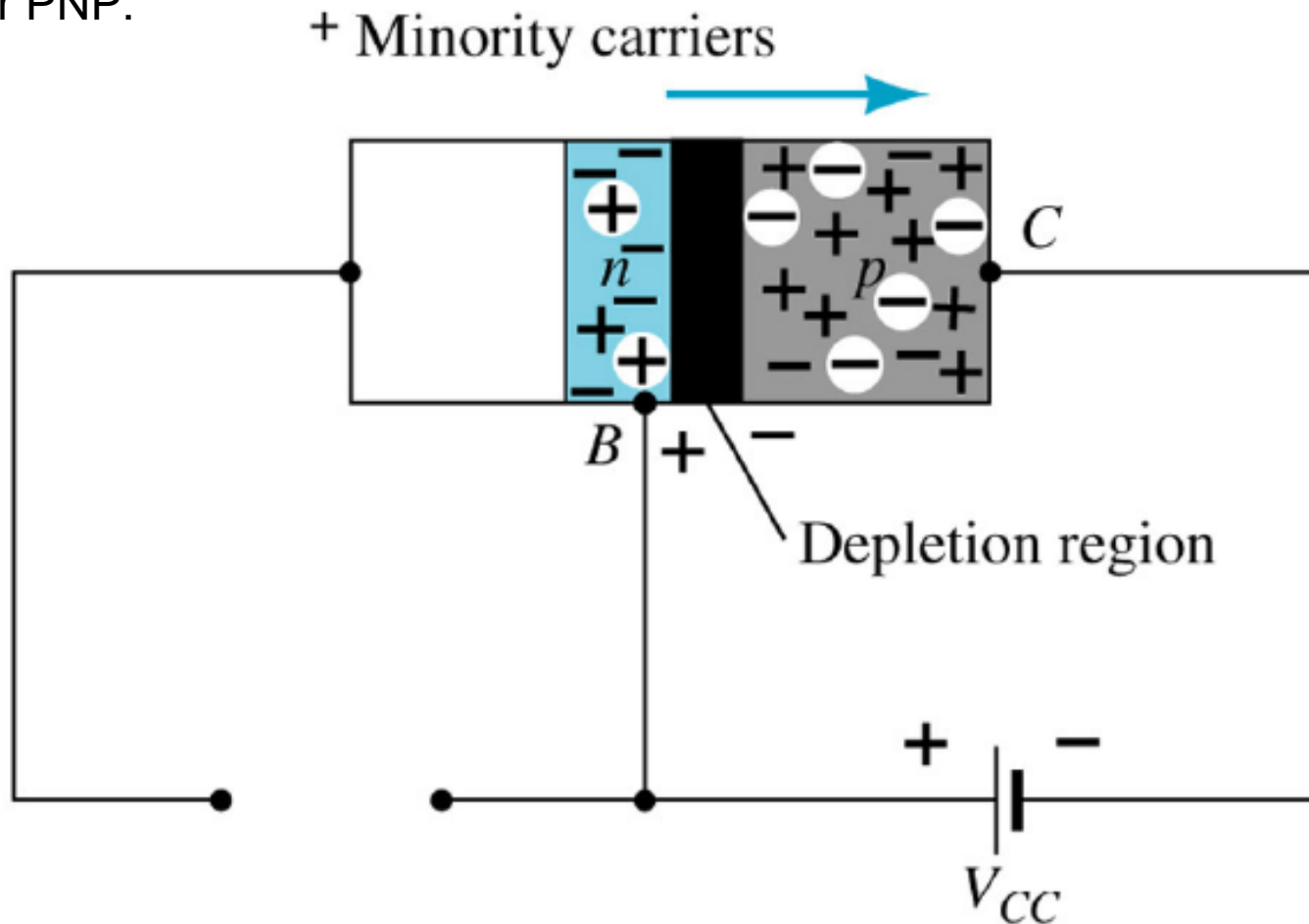

Junção Base – coletor polarizada reversamente.

Operação do transistor

Transistor PNP:

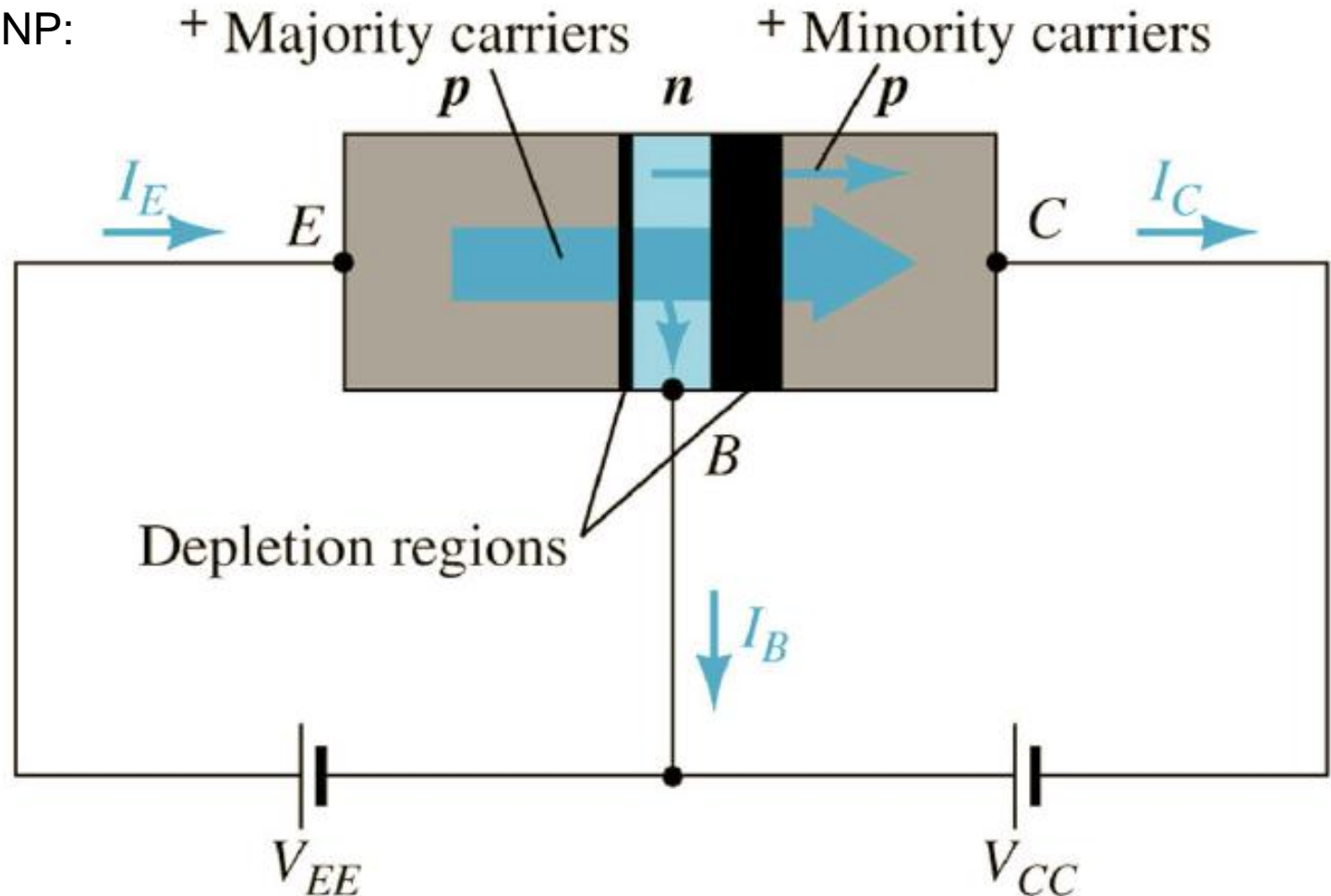

Correntes no transistor bipolar de junção.

Configuração Emissor-Comum

A seta do símbolo gráfico define o sentido da corrente de emissor (fluxo convencional) através do dispositivo.

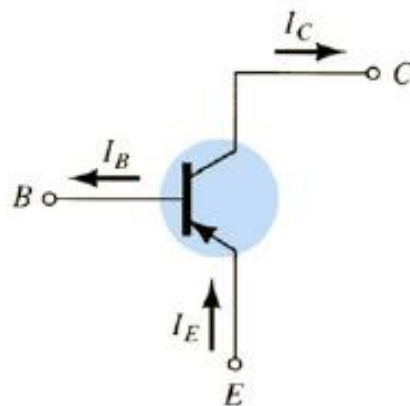
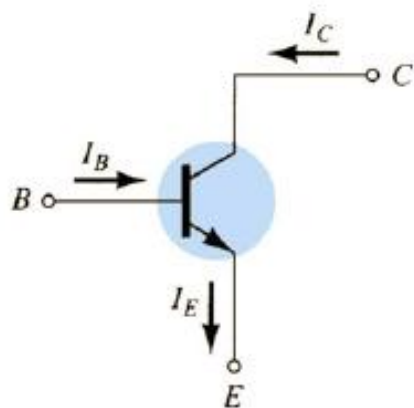
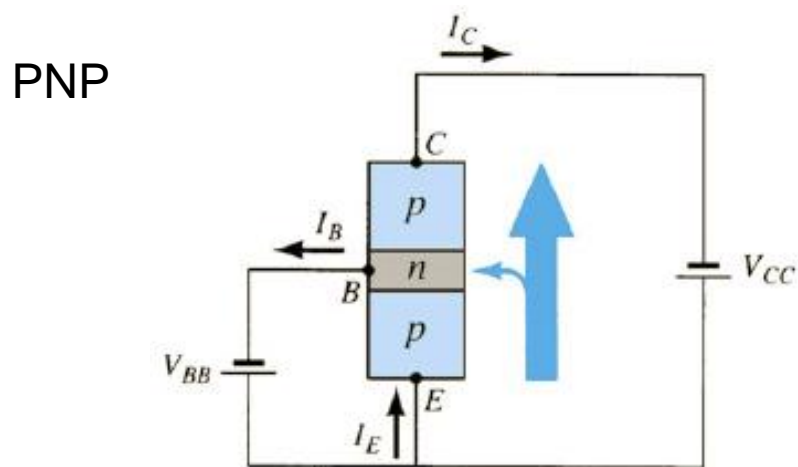
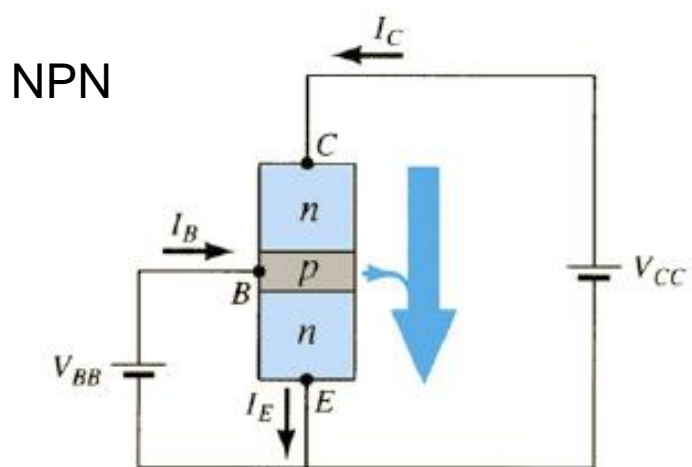

Configuração Emissor-Comum

Na região ativa, a junção base-coletor é polarizada reversamente, enquanto a junção base-emissor é polarizada diretamente.

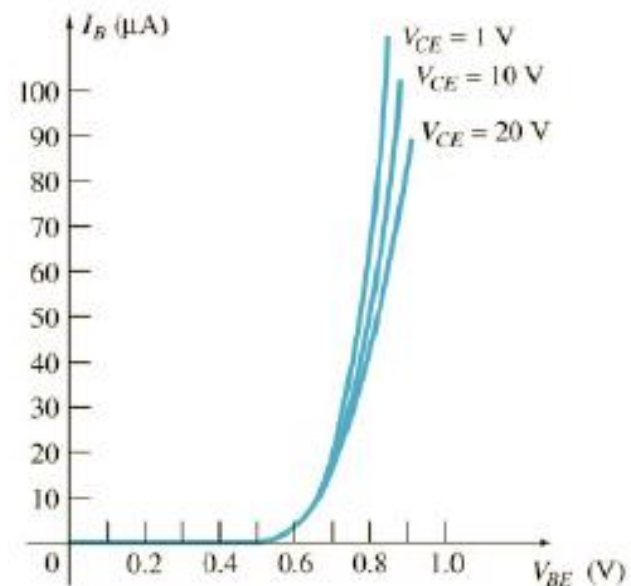
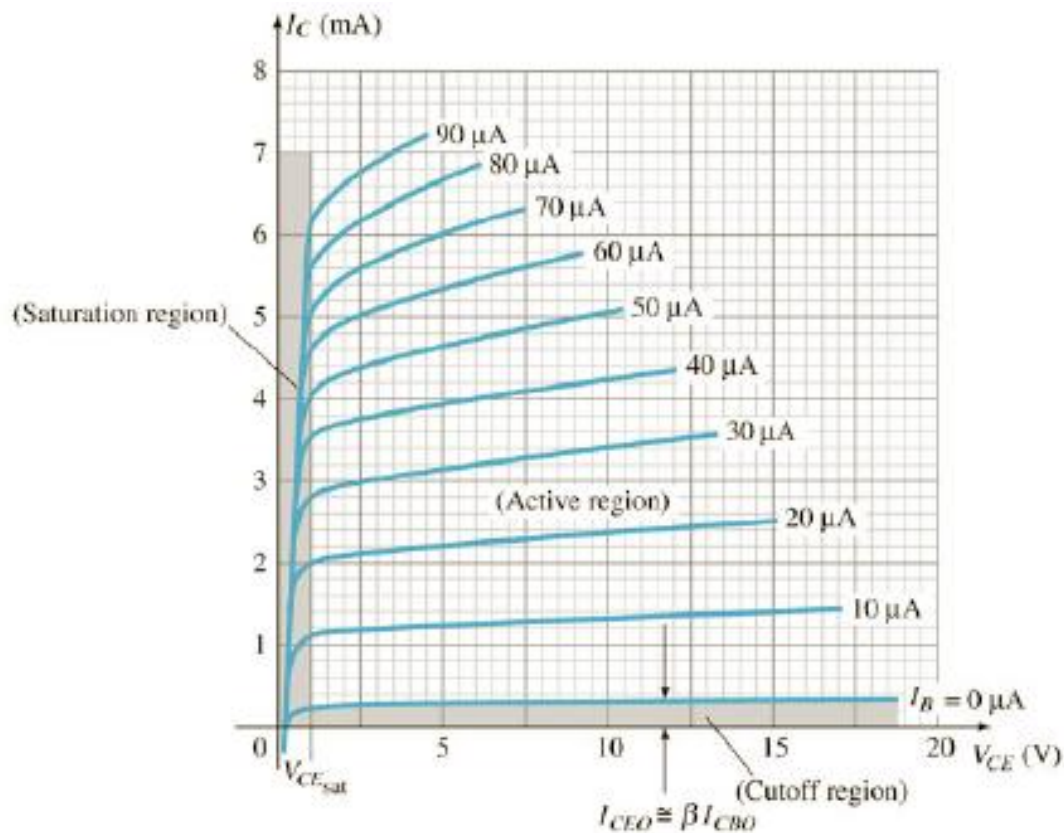

Configuração Emissor-Comum

Aproximação linear das características de base:

$$V_{BE} > 0V$$

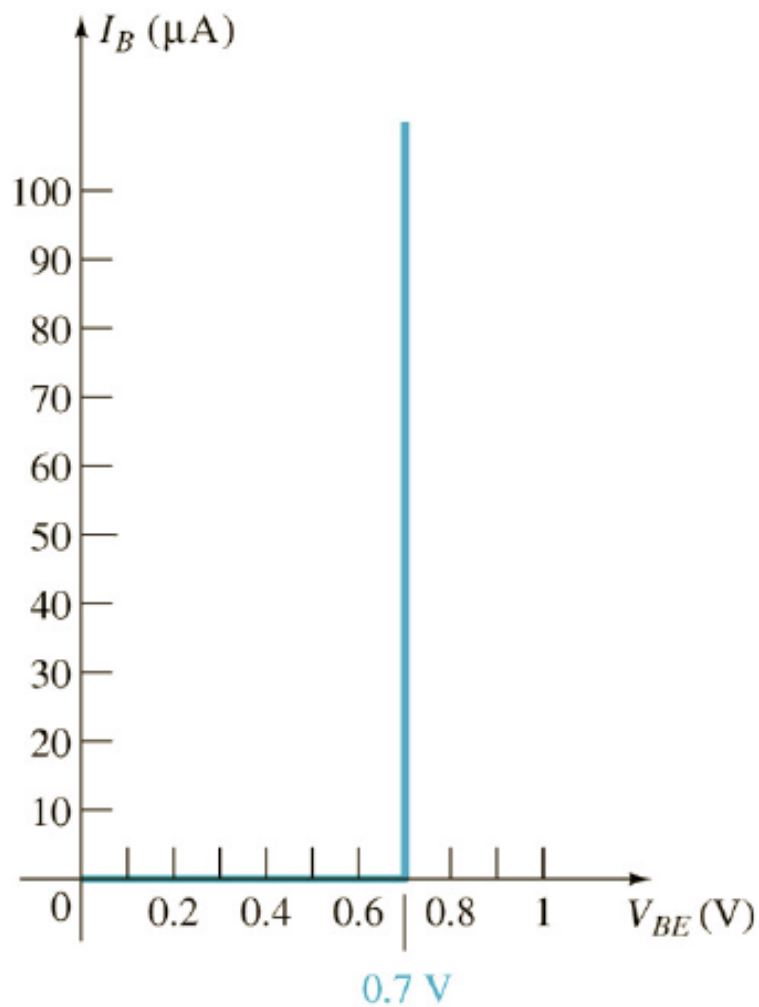

Configuração Emissor-Comum

$$I_E = I_B + I_C$$

$$I_C = \alpha \cdot I_E$$

$$\beta_{cc} = \frac{I_C}{I_B}$$

Ganho CC

Ganho CA

$$\beta_{ca} = \frac{\Delta I_C}{\Delta I_B}$$

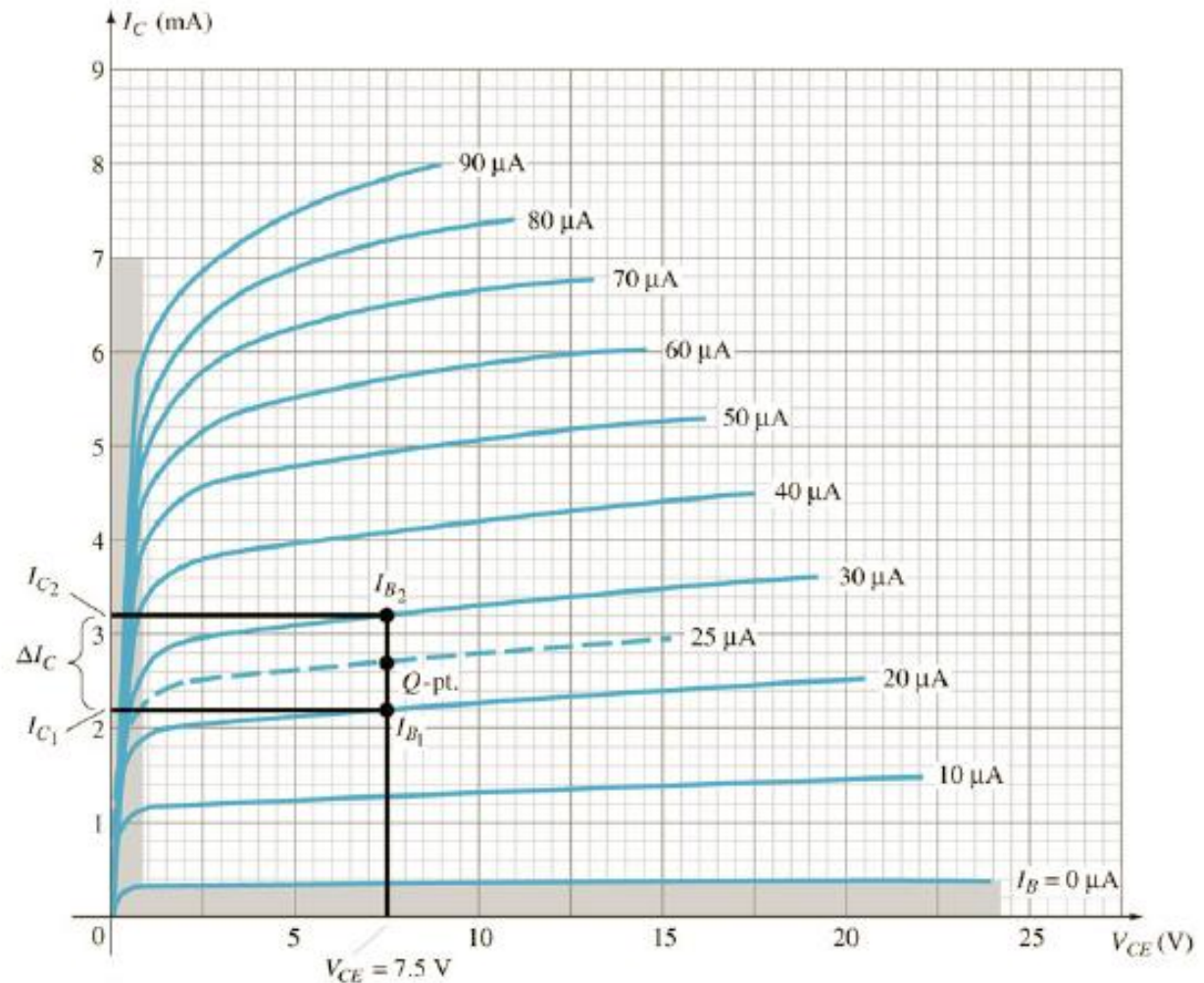

Configuração Emissor-Comum

Exemplo:

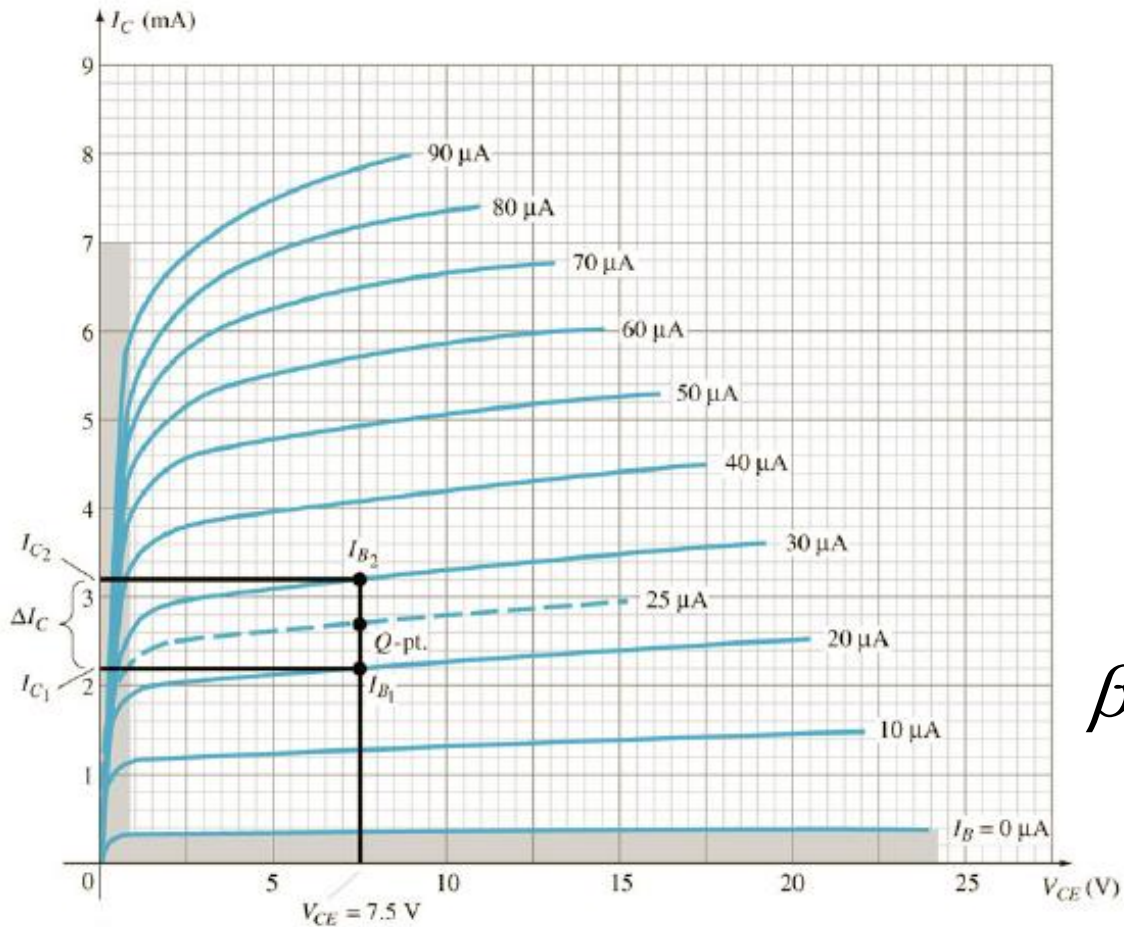

$$\beta_{cc} = \frac{I_C}{I_B} = \frac{2,7\text{m}}{25\mu} = 108$$

$$\beta_{ca} = \frac{\Delta I_C}{\Delta I_B} = \frac{I_{C2} - I_{C1}}{I_{B2} - I_{B1}}$$

$$\beta_{ca} = \frac{3,2\text{m} - 2,2\text{m}}{30\mu - 20\mu} = 100$$

Configuração Emissor-Comum

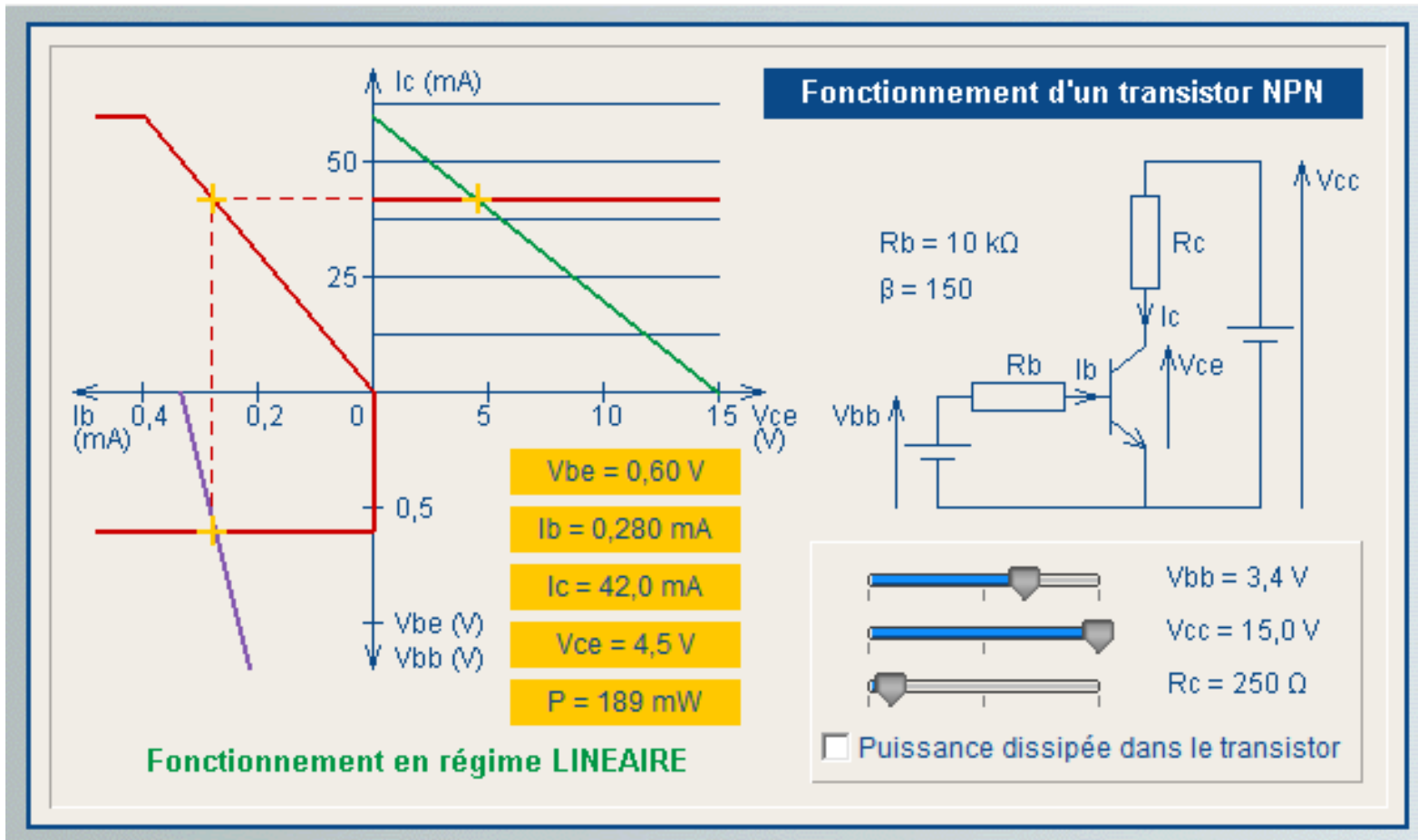

Polarização

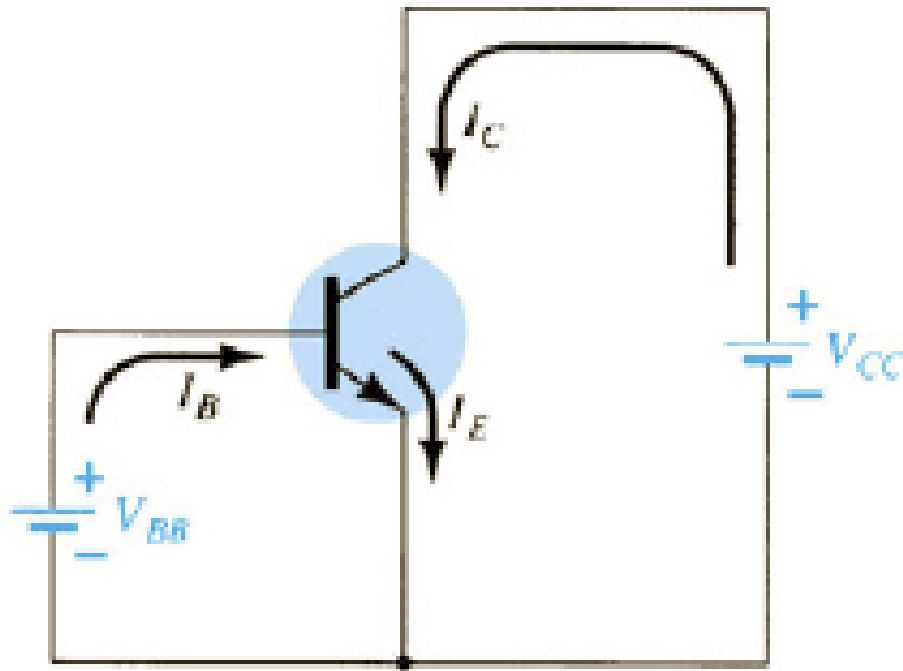

$$I_C = \beta \cdot I_B$$

$$I_E = (\beta + 1) \cdot I_B$$

$$V_{BE} \cong 0,7V$$

Limites de operação

$$P_{Cmax} = V_{CE} \cdot I_C$$

$$I_{CEO} \leq I_C \leq I_{Cmax}$$

$$V_{CEsat} \leq V_{CE} \leq V_{CEmax}$$

$$V_{CE} \cdot I_C \leq P_{Cmax}$$

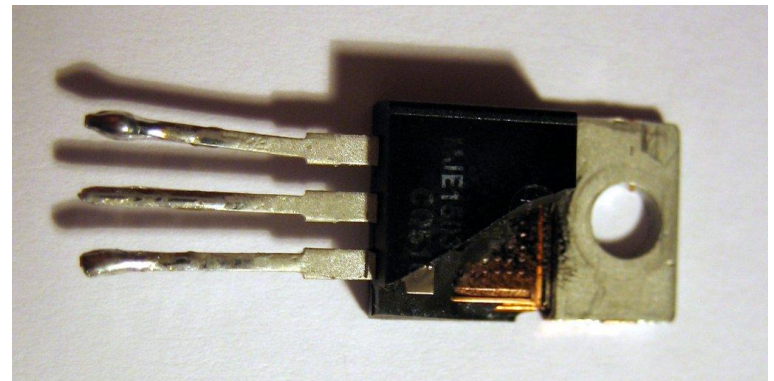
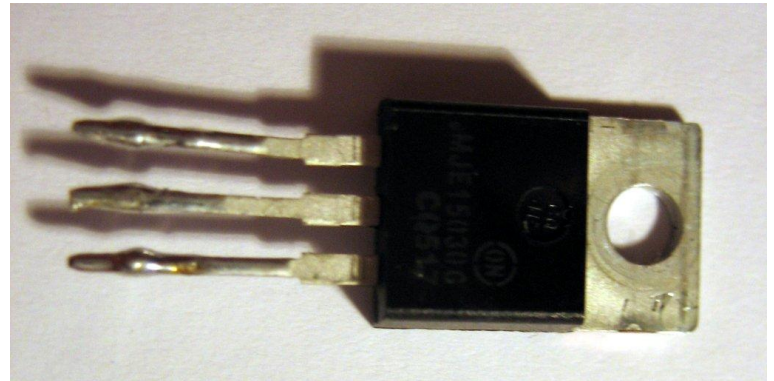
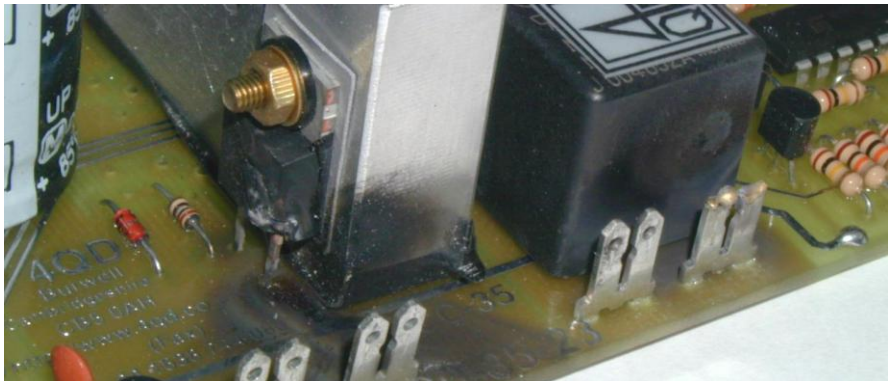

Transistores Darlington

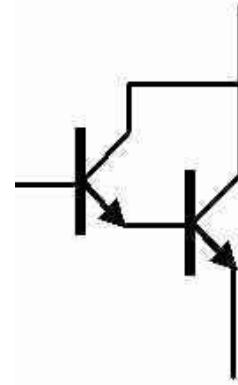
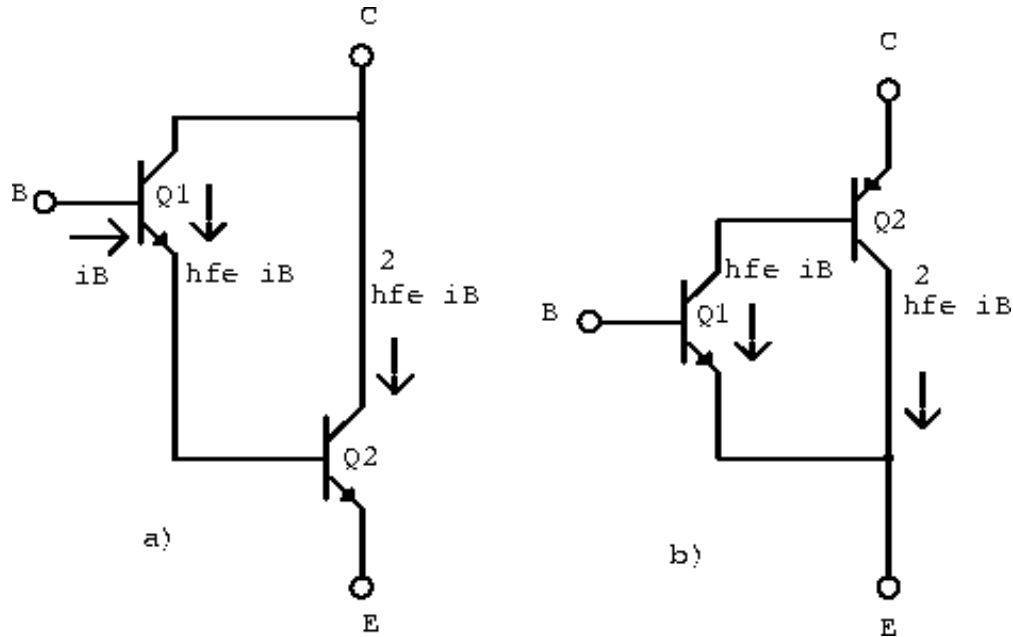

$$\beta_{total} = \beta_1 \cdot \beta_2$$

$$I_B = \frac{I_C}{\beta_{total}}$$

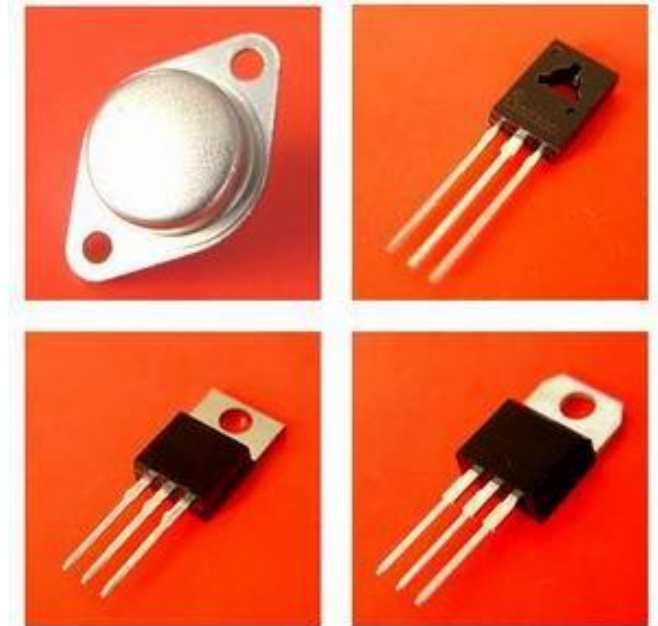
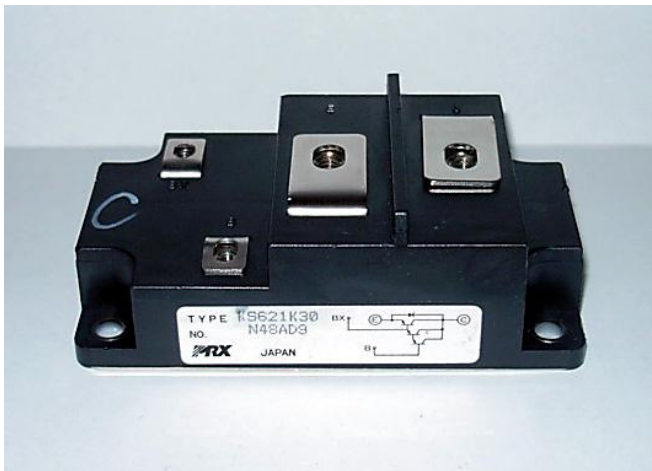

Encapsulamento de transistores

ENCAPSULADOS

TO-105/ TO-106



VISTA DE ABAJO

TO-18/TO-5



VISTA DE ABAJO

TO-71



TO-50

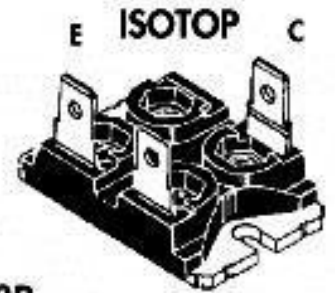
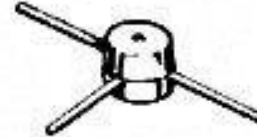

DPAK
TO-252



SOT-23
(SMD)

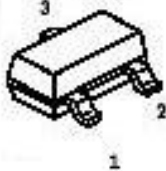

SOT223



TO-126



TO-202

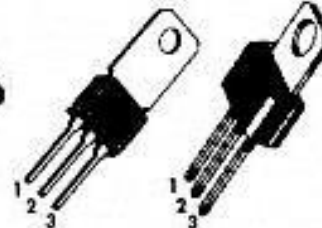

TO-3P

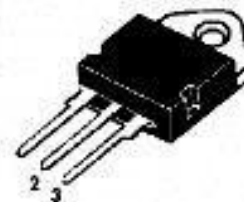

TO-220



TO-3

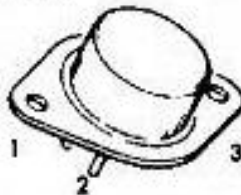

TO-66

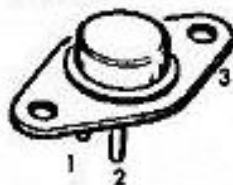

DIL-14



Stx-8



TO-92



Características de catálogo

MAXIMUM RATINGS

Rating	Symbol	2N4123	Unit
Collector-Emitter Voltage	V_{CE0}	30	Vdc
Collector-Base Voltage	V_{CB0}	40	Vdc
Emitter-Base Voltage	V_{EB0}	5.0	Vdc
Collector Current - Continuous	I_C	200	mAdc
Total Device Dissipation @ $T_A = 25^\circ\text{C}$ Dense: above 25°C	P_T	625 5.0	mW mW/°C
Operating and Storage Junction Temperature Range	T_J, T_{stg}	-55 to +150	°C

THERMAL CHARACTERISTICS

Characteristic	Symbol	Max.	Unit
Thermal Resistance, Junction to Case	$R_{\theta(jc)}$	55.3	°C/W
Thermal Resistance, Junction to Ambient	$R_{\theta(ja)}$	200	°C/W

ELECTRICAL CHARACTERISTICS ($T_J = 25^\circ\text{C}$ unless otherwise noted)

Characteristic	Symbol	Min	Max	Unit
OFF CHARACTERISTICS				
Collector-Emitter Breakdown Voltage (1) ($I_C = 1.0\text{ mAdc}, I_E = 0$)	V_{CE0}	30		Vdc
Collector-Base Breakdown Voltage ($I_C = 10\ \mu\text{A}, I_E = 0$)	V_{CB0}	40		Vdc
Emitter-Base Breakdown Voltage ($I_E = 10\ \mu\text{A}, I_C = 0$)	V_{EB0}	5.0		Vdc
Collector Cutoff Current ($V_{CE} = 20\text{ Vdc}, I_E = 0$)	I_{C0}		50	μA
Emitter Cutoff Current ($V_{EB} = 5.0\text{ Vdc}, I_C = 0$)	I_{E0}		50	μA
ON CHARACTERISTICS				
DC Current Gain (1) ($I_C = 2.0\text{ mAdc}, V_{CE} = 1.0\text{ Vdc}$) ($I_C = 50\text{ mAdc}, V_{CE} = 1.0\text{ Vdc}$)	β_{DC}	50 25	150	-
Collector-Emitter Saturation Voltage (1) ($I_C = 50\text{ mAdc}, I_E = 5.0\text{ mAdc}$)	$V_{CE(sat)}$		0.3	Vdc
Base-Emitter Saturation Voltage (1) ($I_C = 50\text{ mAdc}, I_E = 5.0\text{ mAdc}$)	$V_{BE(sat)}$		0.55	Vdc
SMALL-SIGNAL CHARACTERISTICS				
Current Gain - Bandwidth Product ($I_C = 10\text{ mAdc}, V_{CE} = 20\text{ Vdc}, f = 100\text{ MHz}$)	f_T	250		MHz
Output Capacitance ($V_{CE} = 5.0\text{ Vdc}, I_C = 0, f = 100\text{ MHz}$)	C_{out}		4.0	pF
Input Capacitance ($V_{BE} = 0.5\text{ Vdc}, I_C = 0, f = 100\text{ kHz}$)	C_{in}		4.4	pF
Collector-Base Capacitance ($I_C = 0, V_{CB} = 5.0\text{ V}, f = 100\text{ kHz}$)	C_{cb}		4.0	pF
Small-Signal Current Gain ($I_C = 2.0\text{ mAdc}, V_{CE} = 10\text{ Vdc}, f = 1.0\text{ kHz}$)	β_{small}	50	200	-
Current Gain - High Frequency ($I_C = 10\text{ mAdc}, V_{CE} = 20\text{ Vdc}, f = 100\text{ MHz}$) ($I_C = 2.0\text{ mAdc}, V_{CE} = 10\text{ V}, f = 1.0\text{ kHz}$)	β_{hF}	2.5 50		-
Noise Figure ($I_C = 100\ \mu\text{A}, V_{CE} = 5.0\text{ Vdc}, R_L = 1.0\text{ k}\ \Omega, f = 1.0\text{ kHz}$)	NF		6.0	dB

(1) Pulse Test: Pulse Width = 200 μs ; Duty Cycle = 2.0%



Exemplos:

BC548



2N3055



Tipos de transistores

Transistores de uso geral:

PN2222A

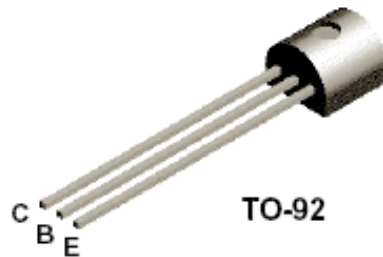

MMBT2222A

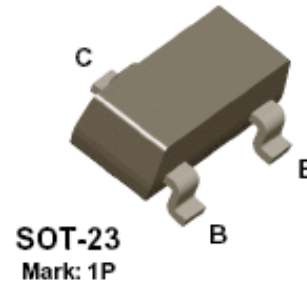

PZT2222A

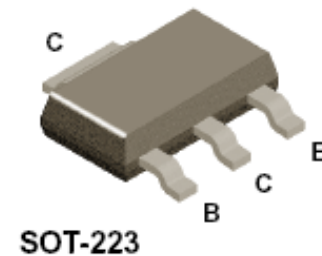

NPN General Purpose Amplifier

This device is for use as a medium power amplifier and switch requiring collector currents up to 500 mA. Sourced from Process 19.



Absolute Maximum Ratings* T_A = 25°C unless otherwise noted

Symbol	Parameter	Value	Units
V _{CEO}	Collector-Emitter Voltage	40	V
V _{CBO}	Collector-Base Voltage	75	V
V _{EB0}	Emitter-Base Voltage	6.0	V
I _C	Collector Current - Continuous	1.0	A
T _J , T _{stg}	Operating and Storage Junction Temperature Range	-55 to +150	°C

Tipos de transistores

Transistores de uso geral:

BC546/547/548/549/550

Switching and Applications

- High Voltage: BC546, $V_{CE0}=65V$
- Low Noise: BC549, BC550
- Complement to BC556 ... BC560

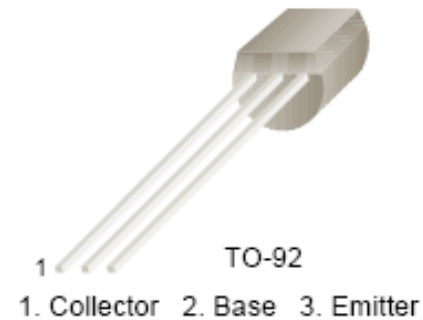

NPN Epitaxial Silicon Transistor

BC556/557/558/559/560

Switching and Amplifier

- High Voltage: BC556, $V_{CE0}= -65V$
- Low Noise: BC559, BC560
- Complement to BC546 ... BC 550

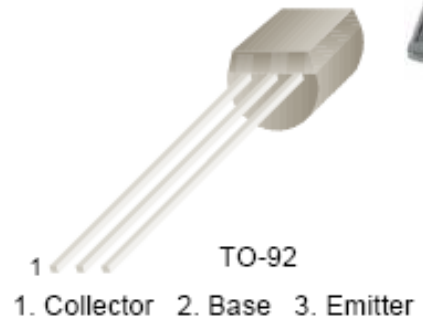

Tipos de transistores

Transistores de uso geral:

BC337/338

Switching and Amplifier Applications

- Suitable for AF-Driver stages and low power output stages
- Complement to BC327/BC328

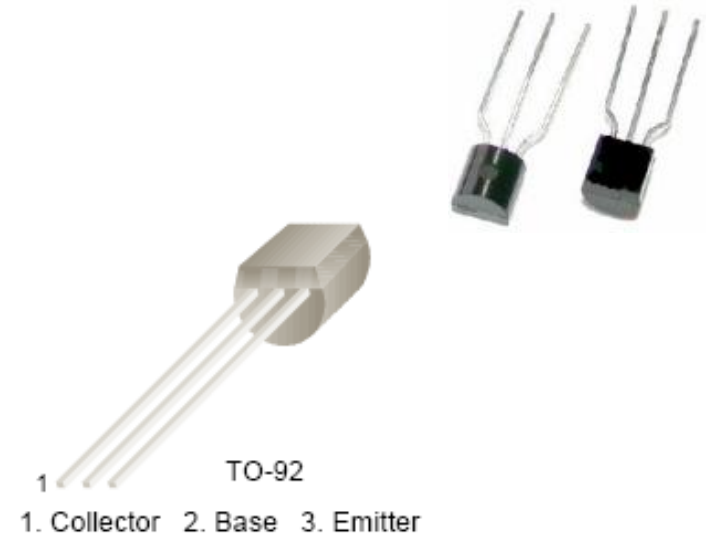

NPN Epitaxial Silicon Transistor

Absolute Maximum Ratings $T_a = 25^\circ\text{C}$ unless otherwise noted

Symbol	Parameter	Value	Units
V_{CES}	Collector-Emitter Voltage		
	: BC337	50	V
	: BC338	30	V
V_{CEO}	Collector-Emitter Voltage		
	: BC337	45	V
	: BC338	25	V
V_{EBO}	Emitter-Base Voltage	5	V
I_C	Collector Current (DC)	800	mA
P_C	Collector Power Dissipation	625	mW
T_J	Junction Temperature	150	$^\circ\text{C}$
T_{STG}	Storage Temperature	-55 ~ 150	$^\circ\text{C}$

Tipos de transistores

Transistores de média potência:

BD135/137/139

Medium Power Linear and Switching Applications

- Complement to BD136, BD138 and BD140 respectively

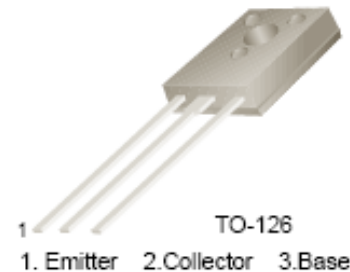

NPN Epitaxial Silicon Transistor

Absolute Maximum Ratings $T_C=25^\circ\text{C}$ unless otherwise noted

Symbol	Parameter	Value	Units
V_{CB0}	Collector-Base Voltage	: BD135	45 V
		: BD137	60 V
		: BD139	80 V
V_{CEO}	Collector-Emitter Voltage	: BD135	45 V
		: BD137	60 V
		: BD139	80 V
V_{EBO}	Emitter-Base Voltage	5	V
I_C	Collector Current (DC)	1.5	A
I_{CP}	Collector Current (Pulse)	3.0	A
I_B	Base Current	0.5	A
P_C	Collector Dissipation ($T_C=25^\circ\text{C}$)	12.5	W
P_C	Collector Dissipation ($T_a=25^\circ\text{C}$)	1.25	W
T_J	Junction Temperature	150	$^\circ\text{C}$
T_{STG}	Storage Temperature	- 55 ~ 150	$^\circ\text{C}$

Tipos de transistores

Transistores de média potência:

TIP31 Series(TIP31/31A/31B/31C)

Medium Power Linear Switching Applications

- Complementary to TIP32/32A/32B/32C

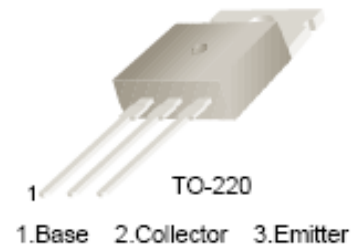

NPN Epitaxial Silicon Transistor

Absolute Maximum Ratings $T_C=25^\circ\text{C}$ unless otherwise noted

Symbol	Parameter	Value	Units	
V_{CBO}	Collector-Base Voltage	: TIP31	40	V
		: TIP31A	60	V
		: TIP31B	80	V
		: TIP31C	100	V
V_{CEO}	Collector-Emitter Voltage	: TIP31	40	V
		: TIP31A	60	V
		: TIP31B	80	V
		: TIP31C	100	V
V_{EBO}	Emitter-Base Voltage	5	V	
I_C	Collector Current (DC)	3	A	
I_{CP}	Collector Current (Pulse)	5	A	
I_B	Base Current	1	A	
P_C	Collector Dissipation ($T_C=25^\circ\text{C}$)	40	W	
P_C	Collector Dissipation ($T_a=25^\circ\text{C}$)	2	W	
T_J	Junction Temperature	150	$^\circ\text{C}$	
T_{STG}	Storage Temperature	- 65 ~ 150	$^\circ\text{C}$	

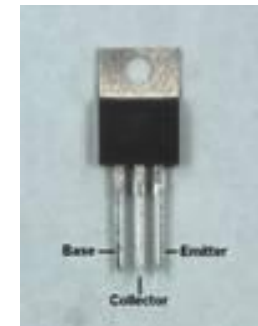

Tipos de transistores

Transistores SMD:

Small Signal Transistors (NPN)

Features

- These transistors are subdivided into three groups (A, B, and C) according to their current gain. The type BC846 is available in groups A and B, however, the types BC847 and BC848 can be supplied in all three groups. The BC849 is a low noise type available in groups B and C. As complementary types, the PNP transistors BC856...BC859 are recommended.
- NPN Silicon Epitaxial Planar Transistors for switching and AF amplifier applications.

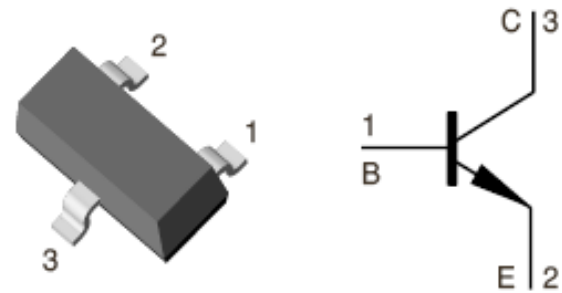

18822



Tipos de transistores

Transistores SMD:

BC846 to BC849

Vishay Semiconductors



Absolute Maximum Ratings

$T_{amb} = 25\text{ }^{\circ}\text{C}$, unless otherwise specified

Parameter	Test condition	Part	Symbol	Value	Unit
Collector - base voltage		BC846	V_{CBO}	80	V
		BC847	V_{CBO}	50	V
		BC848	V_{CBO}	30	V
		BC849	V_{CBO}	30	V
Collector - emitter voltage		BC846	V_{CES}	80	V
		BC847	V_{CES}	50	V
		BC848	V_{CES}	30	V
		BC849	V_{CES}	30	V
		BC846	V_{CEO}	65	V
		BC847	V_{CEO}	45	V
		BC848	V_{CEO}	30	V
		BC849	V_{CEO}	30	V
Emitter - base voltage		BC846	V_{EBO}	6	V
		BC847	V_{EBO}	6	V
		BC848	V_{EBO}	5	V
		BC849	V_{EBO}	5	V
Collector current			I_C	100	mA
Collector peak current			I_{CM}	200	mA
Peak base current			I_{BM}	200	mA
Peak emitter current			$-I_{EM}$	200	mA
Power dissipation	$T_{amb} = 25\text{ }^{\circ}\text{C}$		P_{tot}	310 ¹⁾	mW

Tipos de transistores

Transistores SMD:

BCV26

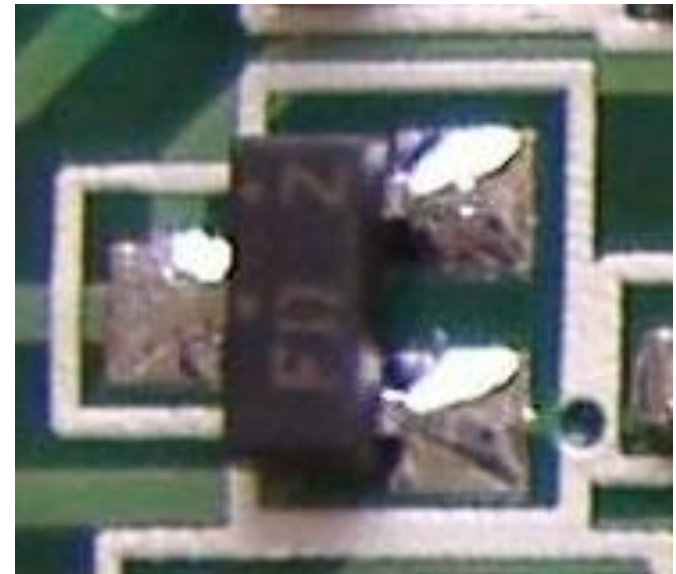
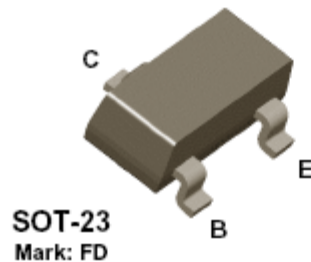

PNP Darlington Transistor

This device is designed for applications requiring extremely high current gain at currents to 800 mA. Sourced from Process 61.

Absolute Maximum Ratings*

TA = 25°C unless otherwise noted

Symbol	Parameter	Value	Units
V_{CE0}	Collector-Emitter Voltage	30	V
V_{CB0}	Collector-Base Voltage	40	V
V_{EB0}	Emitter-Base Voltage	10	V
I_C	Collector Current - Continuous	1.2	A
T_J, T_{stg}	Operating and Storage Junction Temperature Range	-55 to +150	°C

Tipos de transistores

Transistores de alta potência:

Complementary Silicon Power Transistors

... designed for general-purpose switching and amplifier applications.

- DC Current Gain — $h_{FE} = 20-70 @ I_C = 4 \text{ A dc}$
- Collector-Emitter Saturation Voltage —
 $V_{CE(sat)} = 1.1 \text{ Vdc (Max) @ } I_C = 4 \text{ A dc}$
- Excellent Safe Operating Area

MAXIMUM RATINGS

Rating	Symbol	Value	Unit
Collector-Emitter Voltage	V_{CEO}	60	Vdc
Collector-Emitter Voltage	V_{CER}	70	Vdc
Collector-Base Voltage	V_{CB}	100	Vdc
Emitter-Base Voltage	V_{EB}	7	Vdc
Collector Current — Continuous	I_C	15	A dc
Base Current	I_B	7	A dc
Total Power Dissipation @ $T_C = 25^\circ\text{C}$ Derate above 25°C	P_D	115 0.657	Watts W°C
Operating and Storage Junction Temperature Range	T_J, T_{stg}	-65 to +200	$^\circ\text{C}$

THERMAL CHARACTERISTICS

Characteristic	Symbol	Max	Unit
Thermal Resistance, Junction to Case	$R_{\theta JC}$	1.52	$^\circ\text{C/W}$

NPN
2N3055 *
PNP
MJ2955 *

* Motorola Preferred Device

15 AMPERE
POWER TRANSISTORS
COMPLEMENTARY
SILICON
60 VOLTS
115 WATTS



Tipos de transistores

Transistores de alta potência:

**MJ11028, MJ11030,
MJ11032 (NPN)
MJ11029, MJ11033 (PNP)**

High-Current Complementary Silicon Power Transistors

High-Current Complementary Silicon Power Transistors are for use as output devices in complementary general purpose amplifier applications.

Features

- High DC Current Gain – $h_{FE} = 1000$ (Min) @ $I_C = 25$ Adc
 $h_{FE} = 400$ (Min) @ $I_C = 50$ Adc
- Curves to 100 A (Pulsed)
- Diode Protection to Rated I_C
- Monolithic Construction with Built-In Base-Emitter Shunt Resistor
- Junction Temperature to +200°C
- Pb-Free Packages are Available*

MAXIMUM RATINGS ($T_J = 25^\circ\text{C}$ unless otherwise noted)

Rating	Symbol	Value	Unit
Collector-Emitter Voltage MJ11028/29 MJ11030 MJ11032/33	V_{CE0}	60 90 120	Vdc
Collector-Base Voltage MJ11028/29 MJ11030 MJ11032/33	V_{CB0}	60 90 120	Vdc
Emitter-Base Voltage	V_{EB0}	5.0	Vdc
Collector Current - Continuous - Peak (Note 1)	I_C	50 100	Adc
Base Current - Continuous	I_B	2.0	Adc
Total Power Dissipation @ $T_C = 25^\circ\text{C}$ Derate Above 25°C @ $T_C = 100^\circ\text{C}$	P_D	300 1.71	W W/WC
Operating and Storage Junction Temperature Range	T_J, T_{stg}	-55 to +200	$^\circ\text{C}$



ON Semiconductor®

<http://onsemi.com>

**50 AMPERE
COMPLEMENTARY
DARLINGTON POWER
TRANSISTORS
60 - 120 VOLTS
300 WATTS**



TO-204 (TO-3)
CASE 197A
STYLE 1

MARKING DIAGRAM



Tipos de transistores

Transistores de rádio freqüência:

BF959

VHF Transistor

NPN Silicon

Features

- Pb-Free Packages are Available*

MAXIMUM RATINGS

Rating	Symbol	Value	Unit
Collector-Emitter Voltage	V_{CE0}	20	Vdc
Collector-Base Voltage	V_{CBO}	30	Vdc
Emitter-Base Voltage	V_{EBO}	3.0	Vdc
Collector Current - Continuous	I_C	100	mAdc
Total Device Dissipation @ $T_A = 25^\circ\text{C}$ Derate above 25°C	P_D	625 5.0	mW mW/°C
Total Device Dissipation @ $T_C = 25^\circ\text{C}$ Derate above 25°C	P_D	1.5 12	W mW/°C
Operating and Storage Junction Temperature Range	T_J, T_{stg}	-55 to +150	°C

THERMAL CHARACTERISTICS

Characteristic	Symbol	Max	Unit
Thermal Resistance, Junction-to-Ambient	$R_{\theta JA}$	200	°C/W
Thermal Resistance, Junction-to-Case	$R_{\theta JC}$	83.3	°C/W



ON Semiconductor®

<http://onsemi.com>

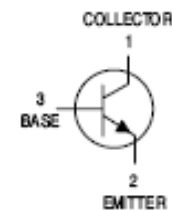

MARKING DIAGRAM



TO-92
CASE 29
STYLE 21

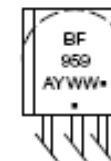

BF959 = Device Code
A = Assembly Location
Y = Year
WW = Work Week
• = Pb-Free Package

Tipos de transistores

Transistores integrados:



(Top View)

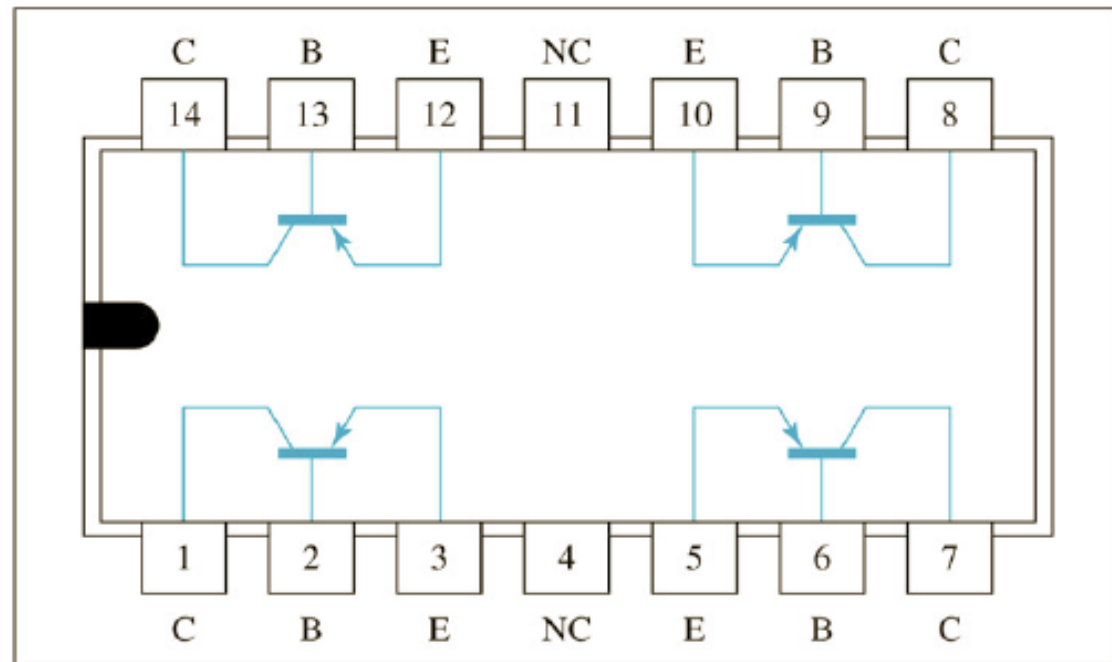

NC – No internal connection

Próxima aula

Seqüência de conteúdos:

1. Polarização de transistores;
2. Operação do transistor como chave;
3. Aplicações.