

## Eletrônica Básica

(1880132A)

Tarefa 01: Considerando os circuitos abaixo, verifique se os diodos estão em condução ou bloqueados.

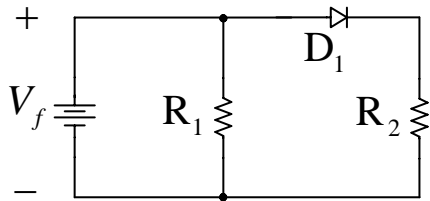

Circuito (a).

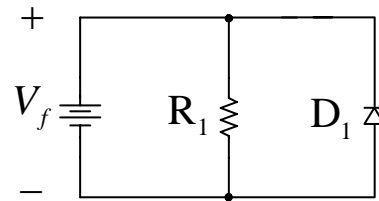

Circuito (b).

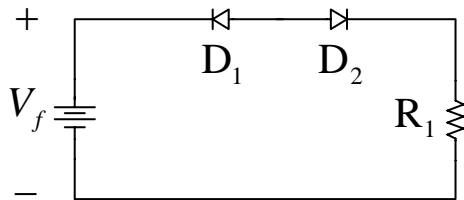

Circuito (c).

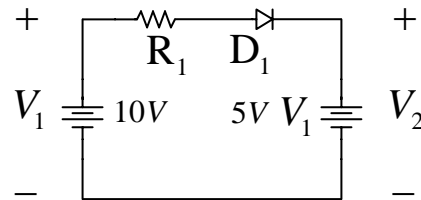

Circuito (d).

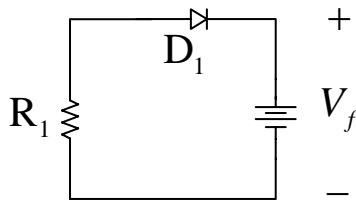

Circuito (e).

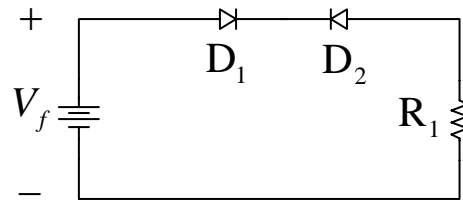

Circuito (f).

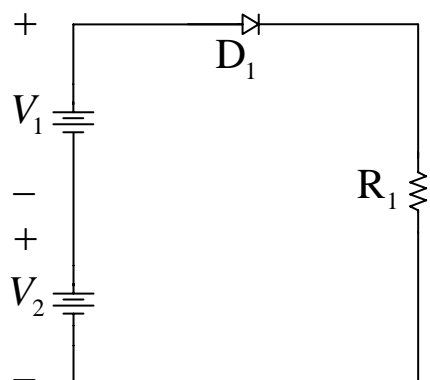

Circuito (g).

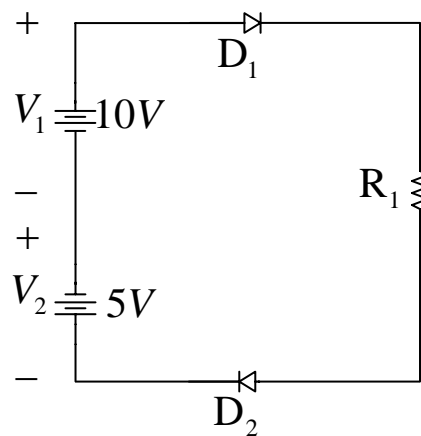

Circuito (h).