

Instituto Federal de Educação, Ciência e Tecnologia de Santa Catarina

Departamento Acadêmico de Eletrônica

Eletrônica de Potência

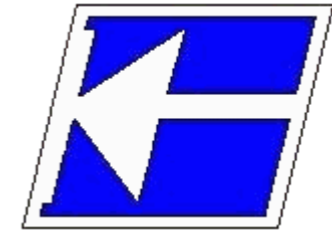

Dimensionamento e Especificação de Semicondutores

Prof. Clovis Antonio Petry.

Florianópolis, fevereiro de 2014.

Biografia para Esta Aula

Capítulos 2, 3 e 4:

- Semicondutores de potência.



www.ProfessorPetry.com.br

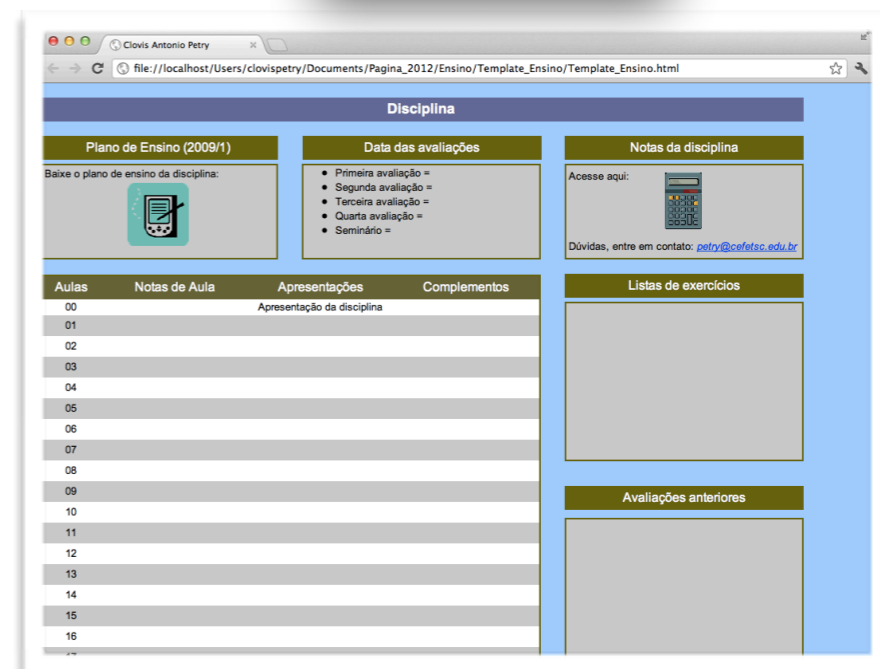

Disciplina

Plano de Ensino (2009/1)

Baixe o plano de ensino da disciplina:

Data das avaliações

- Primeira avaliação =
- Segunda avaliação =
- Terceira avaliação =
- Quarta avaliação =
- Seminário =

Notas da disciplina

Acesse aqui:

Dúvidas, entre em contato: petry@cefetsc.edu.br

Aulas	Notas de Aula	Apresentações	Complementos
00		Apresentação da disciplina	
01			
02			
03			
04			
05			
06			
07			
08			
09			
10			
11			
12			
13			
14			
15			
16			

Listas de exercícios

Avaliações anteriores

Nesta Aula

Semicondutores de potência:

- Introdução;
- Cálculo térmico;
- Exemplos de dimensionamento e especificação.



Cálculo Térmico

Cálculo térmico:

- Objetivo de verificar a necessidade de uso de dissipador de calor ou não.
- Modelo térmico:

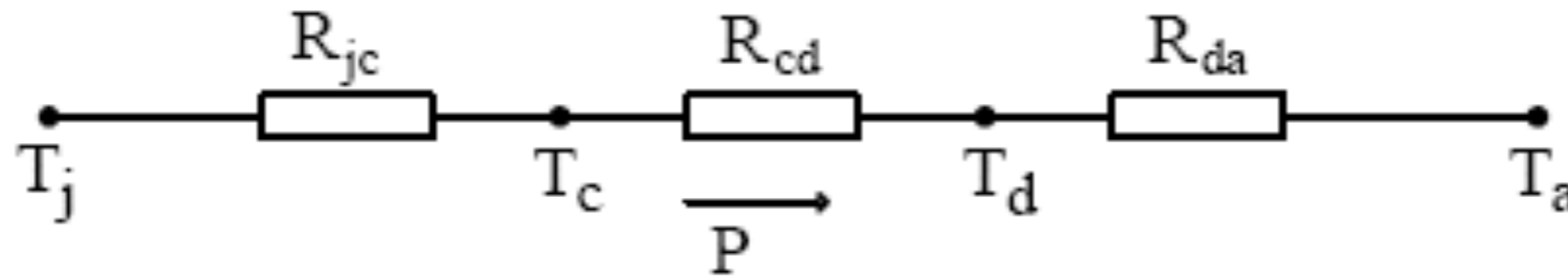

- T_j = temperatura na junção ($^{\circ}\text{C}$);
- T_c = temperatura na cápsula ($^{\circ}\text{C}$);
- T_d = temperatura no dissipador ($^{\circ}\text{C}$);
- T_a = temperatura ambiente ($^{\circ}\text{C}$);
- R_{jc} = resistência térmica entre junção e cápsula ($^{\circ}\text{C}/\text{W}$);
- R_{cd} = resistência térmica entre cápsula e dissipador ($^{\circ}\text{C}/\text{W}$);
- R_{da} = resistência térmica entre dissipador e ambiente ($^{\circ}\text{C}/\text{W}$);
- P = potência dissipada no componente (W).



Cálculo Térmico

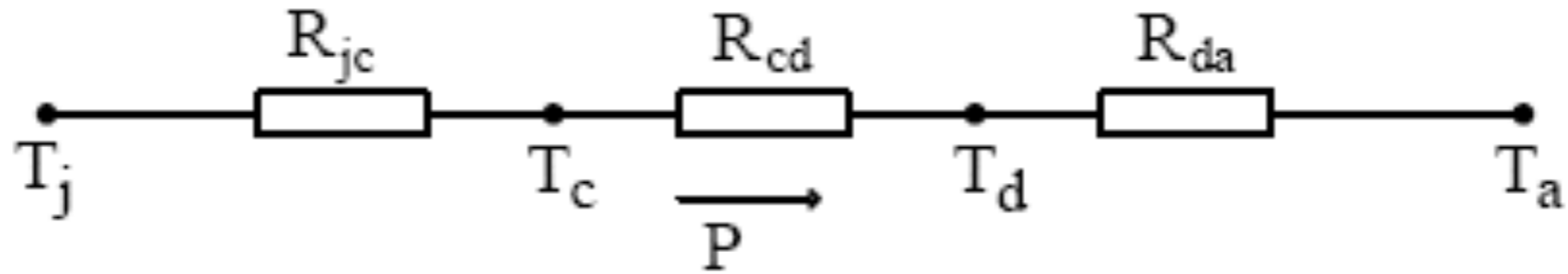

$$R_{ja} = R_{jc} + R_{cd} + R_{da}$$

$$T_j - T_a = R_{ja} \cdot P \quad \longrightarrow \quad R_{ja} = \frac{T_j - T_a}{P}$$

$$R_{da} = R_{ja} - R_{jc} - R_{cd}$$



The screenshot shows the Wolfram CDF Player interface with five sliders and a result box. The sliders are labeled T_a , T_j , R_{jc} , R_{cd} , and P . Each slider has a value displayed to its right, and a plus sign icon to its left. The result box at the bottom displays the value 123.5.

Parameter	Value
T_a	25
T_j	150
R_{jc}	0.5
R_{cd}	1
P	1

123.5

Cálculo Térmico

Exemplo:

- Determinar o dissipador necessário:
 - Diodo MSR1560-D;
 - Corrente média = eficaz = 10 A;
 - Temperatura ambiente de 35 °C;
 - Considerar $R_{cd} = 1 \text{ °C/W}$;
 - Considerar apenas as perdas por condução.



Online Calculator .. Heatsink - Windows Internet Explorer

http://www.changpuak.ch/electronics/calc_23.html

Arguivo Editar Exibir Favoritos Ferramentas Ajuda

Favorites

NI LabVIEW - Improving th... Online Calculator .. He... x

Página Segurança

ONLINE HEATSINK CALCULATOR

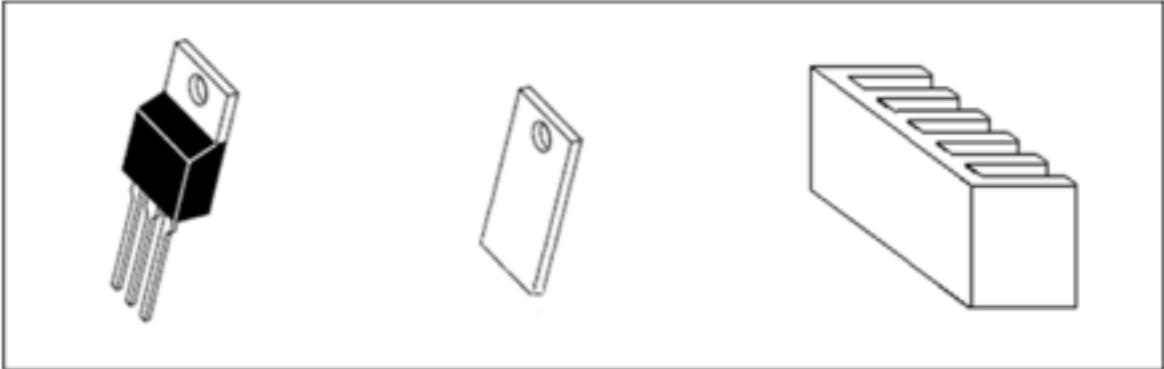

NAVIGATION

go back

MORE INFORMATION

Berechnung Kühlkörper

Heatsink Calculation

LIEBES ELEKTOR TEAM, WER HAT'S ERFUNDEN ?

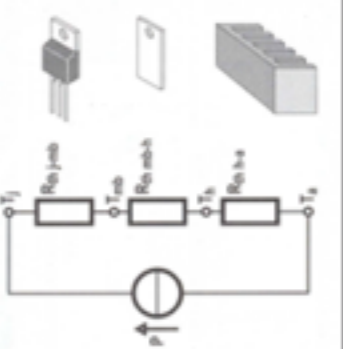

Transistor	Thermal Pad	Heatsink
T_j <input type="text" value="150"/> °C		T_a <input type="text" value="25"/> °C
$R_{th,j-a}$ <input type="text" value="1.5"/> °C/W	R_{th} <input type="text" value="0.3"/> °C/W	R_{th} <input type="text" value="23.2"/> °C/W
P_{diss} <input type="text" value="5"/> W		
<input type="button" value="CALCULATE"/>		

Concluído

Internet | Modo Protegido: Ativado

100%

Natural Convection for Rectangular Heat Sinks - Windows Internet Explorer

http://www.mhtlab.uwaterloo.ca/NC_rect.html

Natural Convection for Rectangular Heat Sinks 

Model Specifications

Configuration:	Single ▾
Solve for:	Source Temperature ▾
Non-Uniform Fin Temperature:	<input type="checkbox"/>
Back Insulated:	<input type="checkbox"/>

Maximum Outer Dimensions
[What is this?](#)

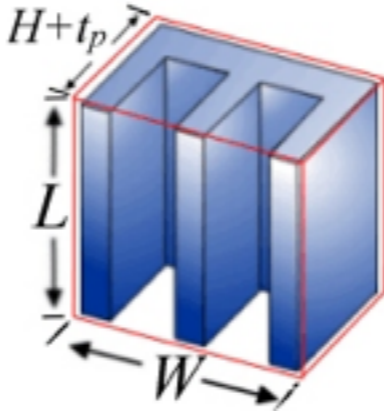

Depth
 $H + t_p$ [mm]

Length
 L [mm]

Width
 W [mm]

Input Values and Results

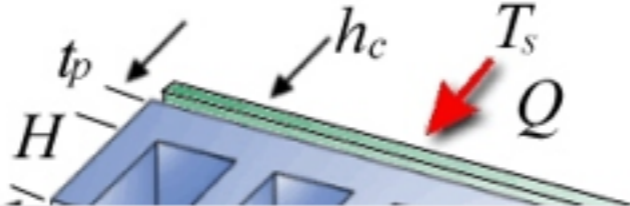

Baseplate Thickness

Contact Conductance
 h_c [W/m² °C]

Concluído

Internet | Modo Protegido: Ativado

100%

Dimensionamento e Especificação de Semicondutores

Exemplo 1:

- Considerando o circuito abaixo:
 - Tensão máxima fornecida pelo painel = 18 V;
 - Corrente máxima fornecida pelo painel = 200 mA;
 - Número de horas em média de insolação = 6 h.

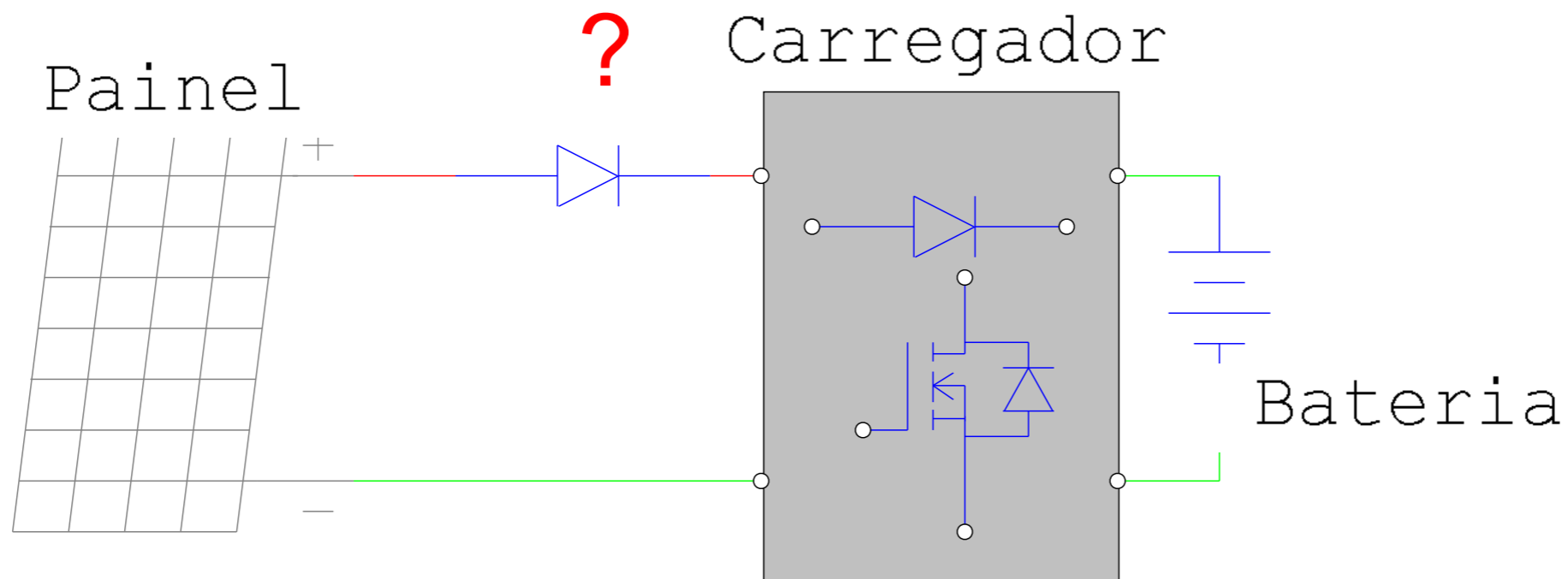

Exemplo 1:

- Especificando o diodo:
 - Tensão máxima = $18 \cdot 1,5 > 30$ V;
 - Corrente máxima = $200 \cdot 2 > 500$ mA;
 - Corrente média = $200 \cdot 1,2 > 250$ mA;
 - Diodo lento, para corrente contínua.

Diodes (1822)

ESD Protection Diodes &
Arrays (129)

Schottky Diodes &
Rectifiers (374)

Small Signal Switching
Diodes (112)

Transient Voltage Suppressors
(TVS) (521)















Tuning Diodes (7)

Zener Diodes (679)



Exemplo 1:

- Escolhendo o diodo:

Select	Product	Data Sheet	Pb-free	Status	Description	V _{RRM} Min (V)	V _F Max (V)	I _{RM} Max (uA)	I _{O(rec)} Max (A)	I _{FSM} Max (A)	t _{rr} Max (ns)	C _j Max (pF)	Package	Price
<input type="checkbox"/>	MBR0530T1			Active	0.5 A, 30 V Schottky Rectifier	30	0.43 	130 	0.5	5.5			SOD-123 2 LEAD	\$0.1267
<input type="checkbox"/>	MBR0530T1G			Active	0.5 A, 30 V Schottky Rectifier	30	0.43 	130 	0.5	5.5			SOD-123 2 LEAD	\$0.1175
<input type="checkbox"/>	MBR0530T3G			Active	0.5 A, 30 V Schottky Rectifier	30	0.43 	130 	0.5	5.5			SOD-123 2 LEAD	\$0.1175
<input type="checkbox"/>	NSR0530P2T5G			Active	30V 0.5A low VF SOD-923 Schottky Diode	30	0.46 	200 	0.5				SOD-923, 0.40 Max Height	\$0.064

www.onsemi.com

Features

- Very Low Forward Voltage Drop - 370 mV @ 100 mA
- Low Reverse Current - 1.4 μ A @ 10 V VR
- 500 mA of Continuous Forward Current
- Power Dissipation of 190 mW with Minimum Trace
- Very High Switching Speed
- Low Capacitance - CT = 10 pF
- This is a Pb-Free Device

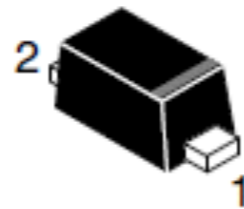

Dimensionamento e Especificação de Semicondutores

Exemplo 2:

- Considerando o circuito abaixo:
 - Tensão da rede $220\text{ V} \pm 20\%$;
 - Carga (chuveiro) de 6800 W ;
 - Pior caso = tiristor conduzindo o tempo todo.

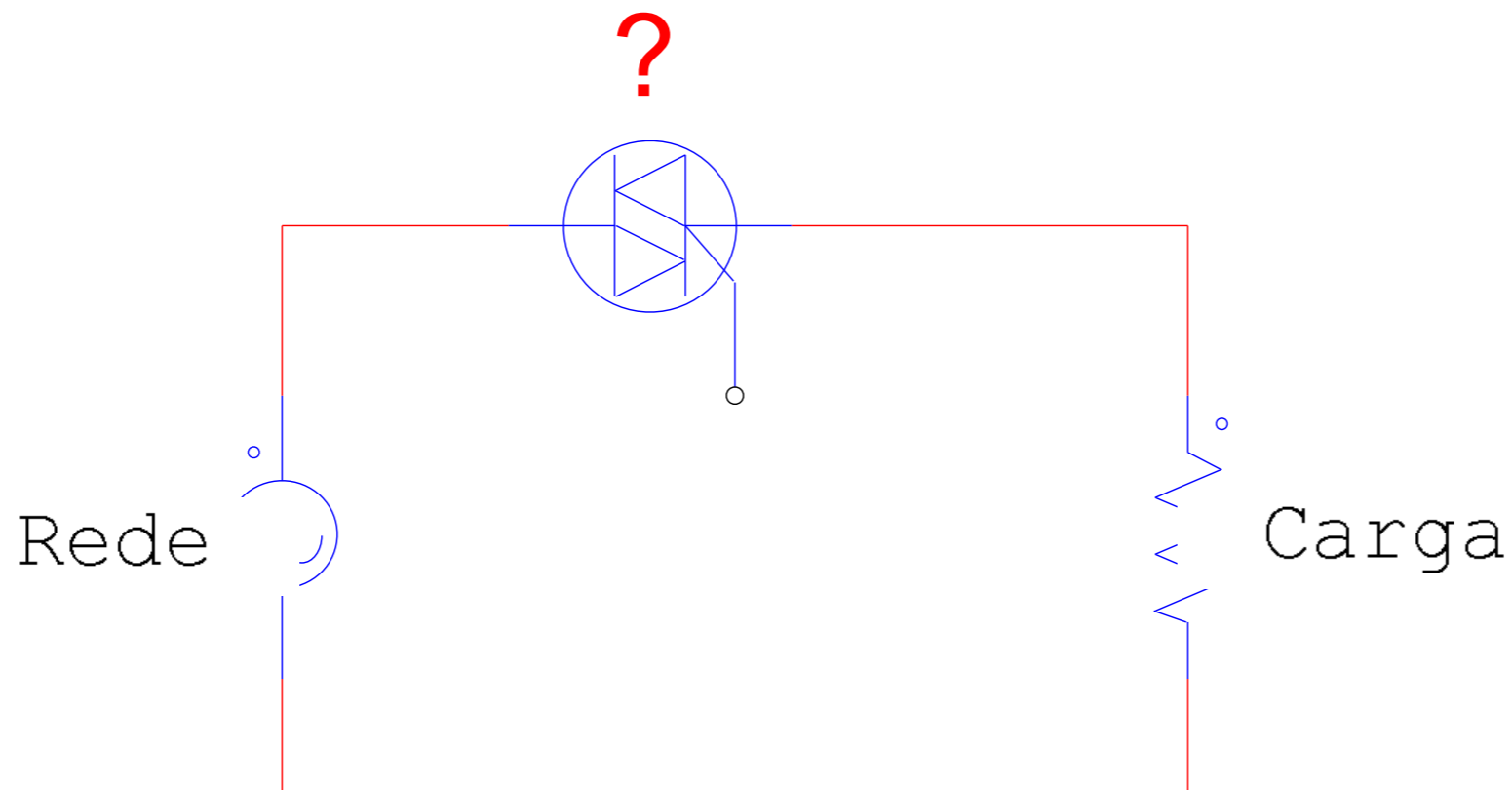

Exemplo 2:

- Especificando o tiristor:
 - Tensão máxima = $[(220+20\%) \cdot 1,41] \cdot 1,2 > 500 \text{ V}$;
 - Corrente máxima = $[(6800/220) \cdot 1,41] \cdot 1,2 > 53 \text{ A}$;
 - Corrente eficaz = $(6800/220) \cdot 1,2 > 37 \text{ A}$;
 - Tiristor lento, para 60 Hz.

Thyristors (456)

Programmable Unijunction
Transistors (PUTs) (12)

SIDACs (11)

Silicon Controlled Rectifiers
(SCRs) (163)

Thyristor Surge Protection
Devices (TSPDs) (93)

Triacs (177)



Não atende!!



Exemplo 2:

- Especificando o tiristor:
 - Tensão máxima = $[(220+20\%) \cdot 1,41] \cdot 1,2 > 500 \text{ V}$;
 - Corrente máxima = $[(6800/220) \cdot 1,41] \cdot 1,2 > 53 \text{ A}$;
 - Corrente eficaz = $(6800/220) \cdot 1,2 > 37 \text{ A}$;
 - Tiristor lento, para 60 Hz.

Thyristors & AC Switches Families

SCR

Sensitive Gate SCRs
Standard SCRs
Voltage Switches

Triac

Snubberless High Tj Triacs
Standard and Snubberless Triacs

Diac

Diacs

AC Switches

AC Switch

ASD Thyristor

Ignitors Industrial
Ignitors Lighting
Power Control

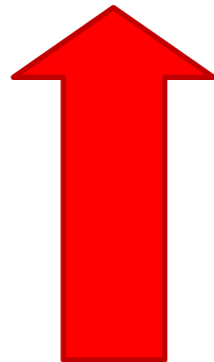

Dimensionamento e Especificação de Semicondutores

Exemplo 2:

- Escolhendo o tiristor:

Generic Part Number		Orderable Part Number	Status
<u>BTA40</u>	Purchase	<u>BTA40-600B</u>	Active
	Purchase	<u>BTA40-800B</u>	Active
<u>BTA41</u>	Purchase	<u>BTA41-600BRG</u>	Active
	Purchase	Samples <u>BTA41-800BRG</u>	Active
<u>BTB41</u>	Purchase	<u>BTB41-800BRG</u>	Active
	Purchase	Samples <u>BTB41-600BRG</u>	Active

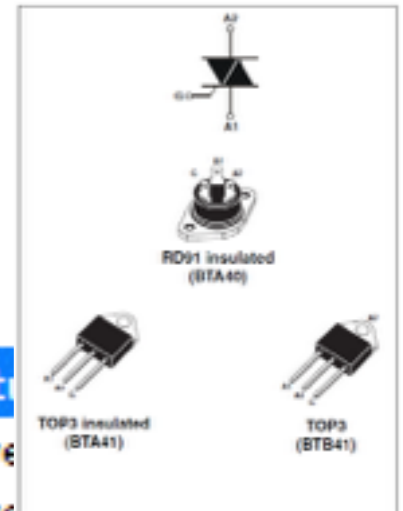

Symbol	Parameter	BTA40 ⁽¹⁾	BTA41 ⁽¹⁾	BTB41	Unit
$I_{T(RMS)}$	On-state rms current	40	41	41	A
V_{DRM}/V_{RRM}	Repetitive peak off-state voltage	600 and 800	600 and 800	600 and 800	V
I_{GT}	Triggering gate current	50	50	50	mA

Exemplo 2:

- Projetando o dissipador para o tiristor:

Symbol	Test conditions		Value	Unit	
$R_{th(j-c)}$	Junction to case (AC)	RD91 (insulated) / TOP3 insulated	0.9	$^{\circ}C/W$	
		TOP3	0.6		
$R_{th(j-a)}$	Junction to ambient	TOP3 / TOP3 insulated	50	$^{\circ}C/W$	
T_{stg} T_j	Storage junction temperature range Operating junction temperature range		- 40 to + 150 - 40 to + 125	$^{\circ}C$	
$R_d^{(2)}$	Dynamic resistance	$T_j = 125^{\circ}C$	MAX.	10	$m\Omega$

$$P = R \cdot I^2 = 10 \cdot 10^3 \cdot \left(\frac{6800}{220} \right)^2 = 9,55W$$

$$R_{ja} = \frac{T_j - T_a}{P} = \frac{125 - 40}{9,55} = 8,9^{\circ}C / W$$

$$R_{da} = R_{ja} - R_{jc} - R_{cd}$$

$$R_{da} = 8,9 - 0,6 - 1 = 7,3^{\circ}C / W$$

Exemplo 2:

- Escolhendo o dissipador:

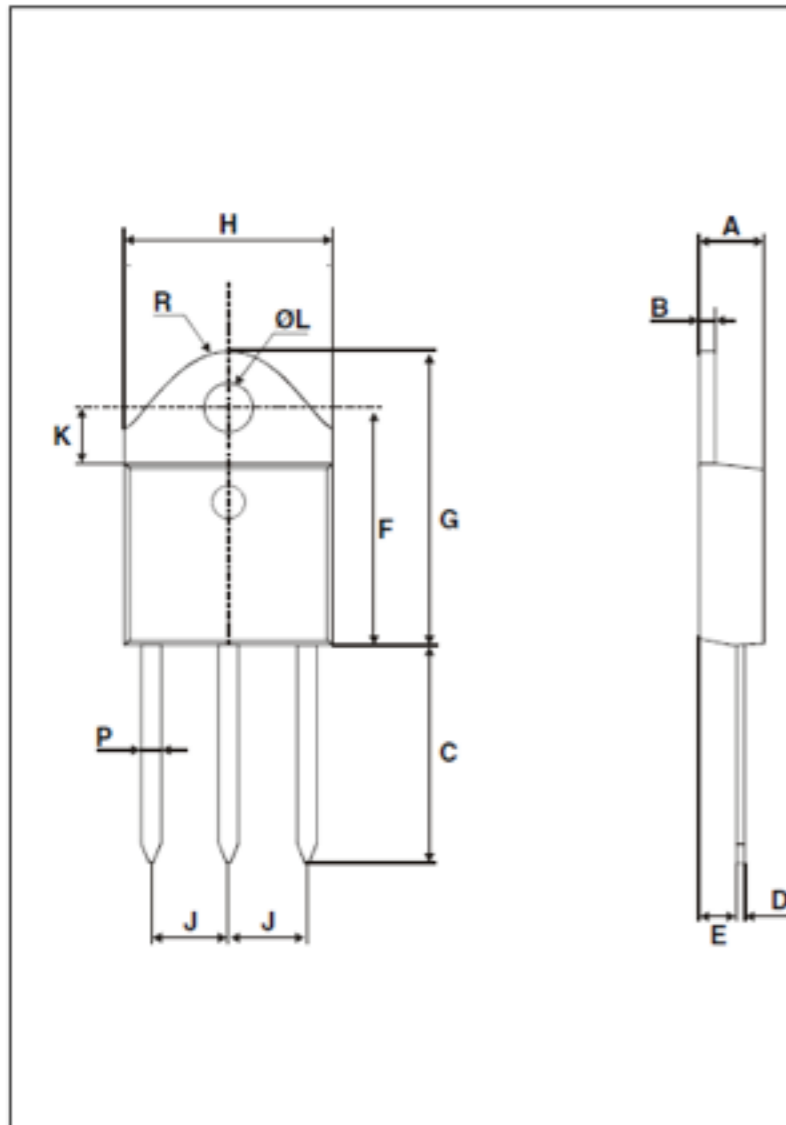

Ref.	Dimensions			
	Millimeters		Inches	
	Min.	Max.	Min.	Max.
A	4.4	4.6	0.173	0.181
B	1.45	1.55	0.057	0.061
C	14.35	15.60	0.565	0.614
D	0.5	0.7	0.020	0.028
E	2.7	2.9	0.106	0.114
F	15.8	16.5	0.622	0.650
G	20.4	21.1	0.815	0.831
H	15.1	15.5	0.594	0.610
J	5.4	5.65	0.213	0.222
K	3.4	3.65	0.134	0.144
ØL	4.08	4.17	0.161	0.164
P	1.20	1.40	0.047	0.055
R	4.60 typ.		0.181 typ.	



Dimensionamento e Especificação de Semicondutores

Exemplo 2:

- Escolhendo o dissipador:

$$\text{Fator de correção} = 7,3/5,72 = 1,276$$

Código : HS 3030

Dimensões aproximadas: 30 x 30 mm

Perímetro: 270 mm

Resistência Térmica: 5,72 °C / W / 4"

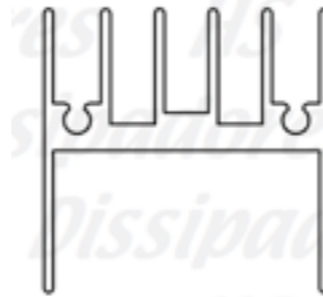

ESCALA 1:1

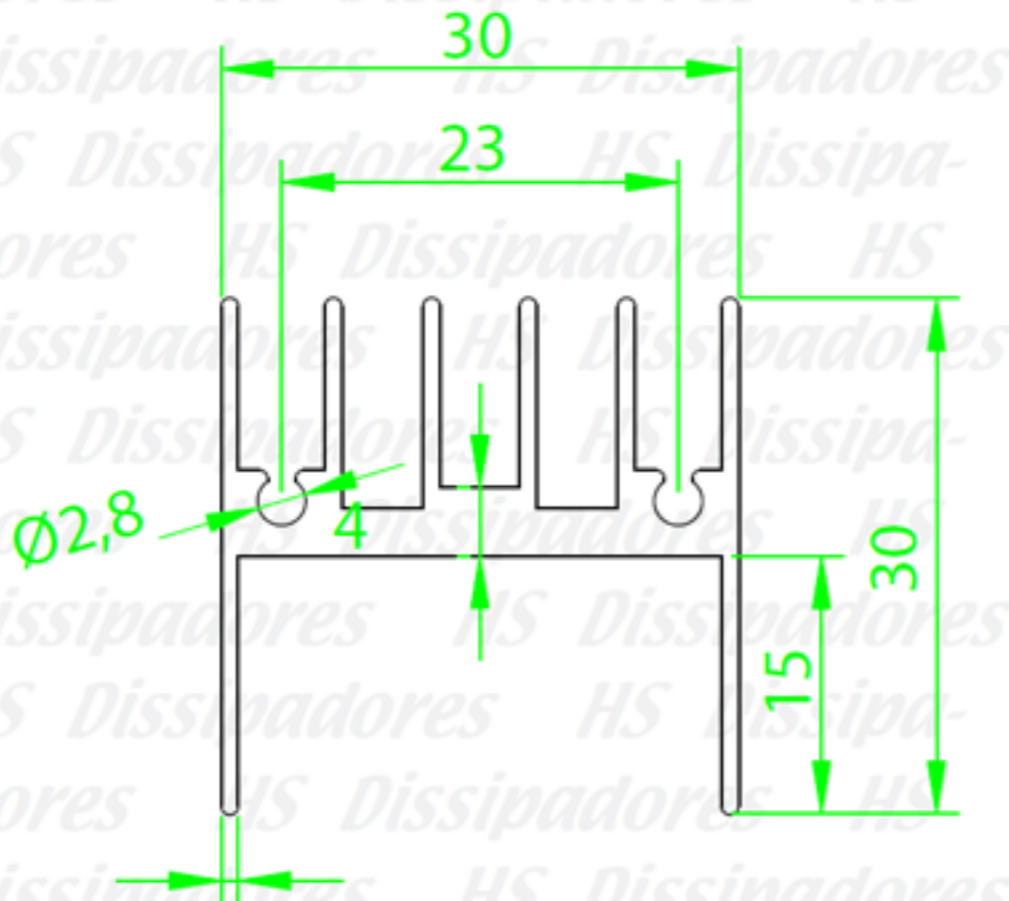

comprimento	fator de correção
10 mm	3,05
20 mm	2,21
30 mm	1,82
40 mm	1,59
50 mm	1,43
70 mm	1,22
100 mm	1,04

Retificadores monofásicos:

- Carga resistiva.

