

Instituto Federal de Educação, Ciência e Tecnologia de Santa Catarina

Departamento Acadêmico de Eletrônica

Eletrônica de Potência



# Projeto de Elementos Magnéticos

## Revisão de Eletromagnetismo

Prof. Clovis Antonio Petry.

Florianópolis, abril de 2014.

# Biografia para Esta Aula

## Revisão de eletromagnetismo:

- Conceitos iniciais;
- Grandezas eletromagnéticas;
- Perdas magnéticas;
- Tipos de núcleos;
- Lei de Lenz e Lei de Faraday;
- Indutores e transformadores.



**TEXAS INSTRUMENTS** <http://www.ti.com>

2001 Magnetics Design Handbook - MAG100A

Duration	1 Day
Price	Free
Course Documents/ Reference Material	<p>Ref. Design Sect. R3-1: Coupled Filter Inductors Yield Improved Performance</p> <p>Introduction and Basic Magnetics (Magnetics Design for Six Power Supplies)</p> <p>Magnetic Core Characteristics</p> <p>Windings</p> <p>Power Transformer Design</p> <p>Inductor and Flyback Transformer Design</p> <p>Ref. Design Sect. R1-1: Magnetic Core Properties</p> <p>Ref. Design Sect. R2-1: Eddy Current Losses in X-former Windings</p> <p>Ref. Design Sect. R3-1: Deriving the Equivalent Electrical Circuit</p> <p>Ref. Design Sect. R4-1: The Effect of Leakage Inductance on Performance</p> <p>Ref. Design Sect. R6-1: How to Design a Transformer with Fractional Turns</p> <p>Ref. Design Sect. R7-1: Winding Data</p> <p>All 2001 Magnetics Design Handbook Sections in a single compressed zip file</p>

[www.ProfessorPetry.com.br](http://www.ProfessorPetry.com.br)



Disciplina

Plano de Ensino (2009/1)

Data das avaliações

Notas da disciplina

Aulas

Notas de Aula

Apresentações

Complementos

Listas de exercícios

Avaliações anteriores

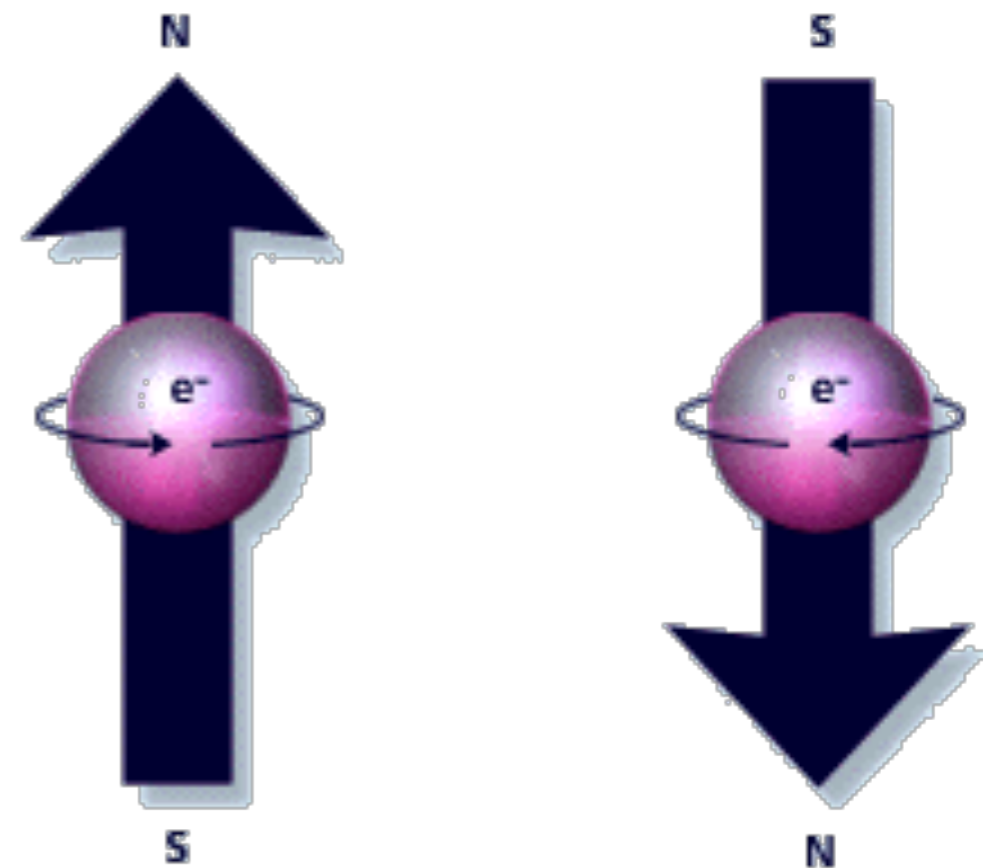
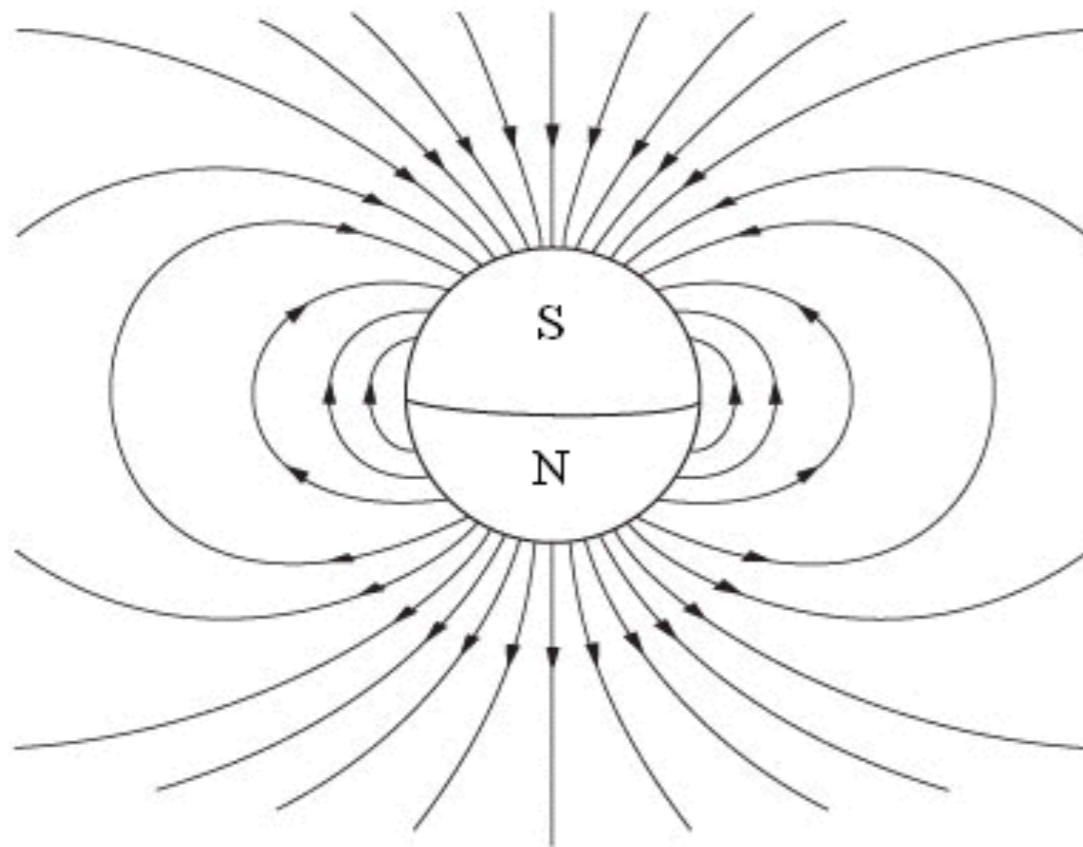
## Revisão de eletromagnetismo:

- Conceitos iniciais;
- Grandezas eletromagnéticas;
- Perdas magnéticas;
- Tipos de núcleos;
- Lei de Lenz e Lei de Faraday;
- Indutores e transformadores.

# Conceitos Iniciais

## Dipolos magnéticos:

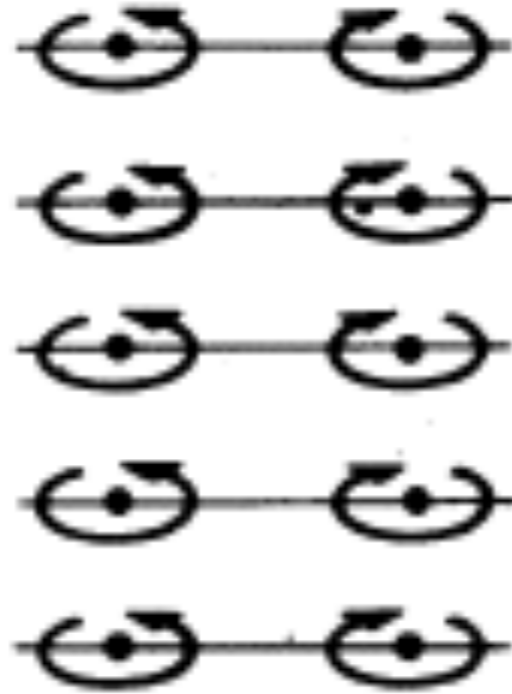
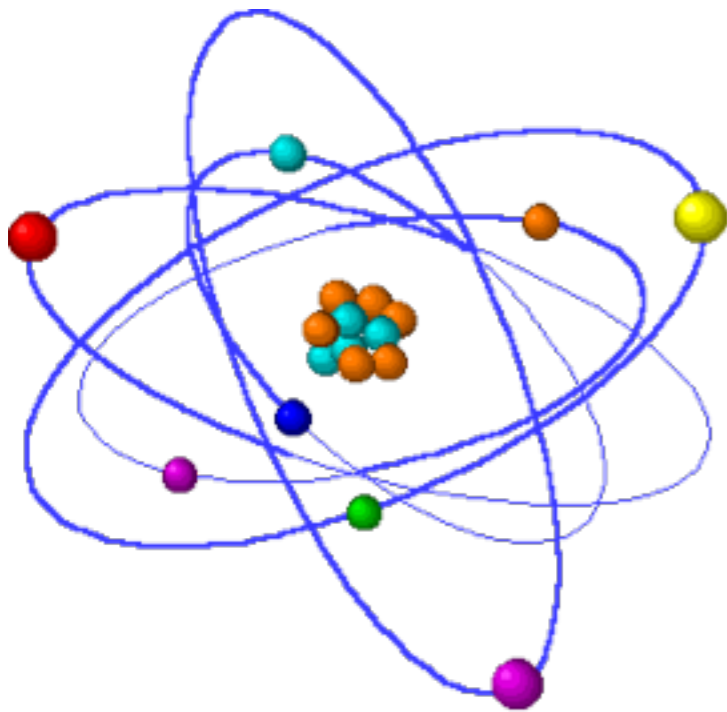
- Determinam o comportamento dos materiais num campo magnético;
- Tem origem no momentum angular dos elétrons nos íons ou átomos que formam a matéria.



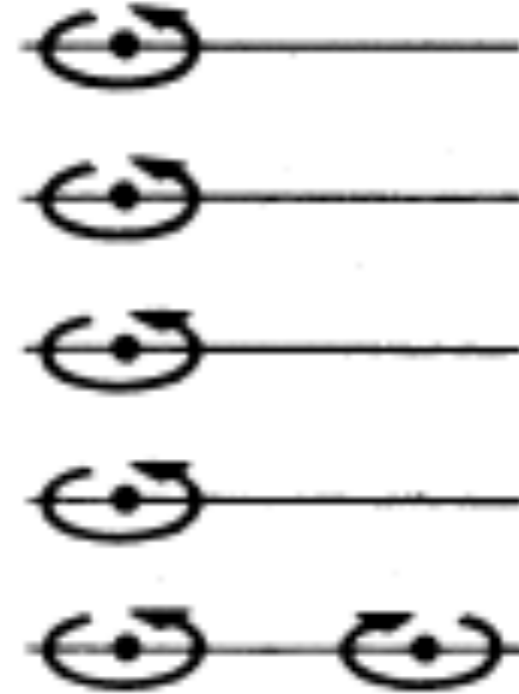
# Conceitos Iniciais

## Magnetismo atômico:

- 2 elétrons ocupam o mesmo nível energético;
- Estes elétrons tem spins opostos;
- Subníveis internos não completos dão origem a um momento magnético não nulo.



Momento = 0

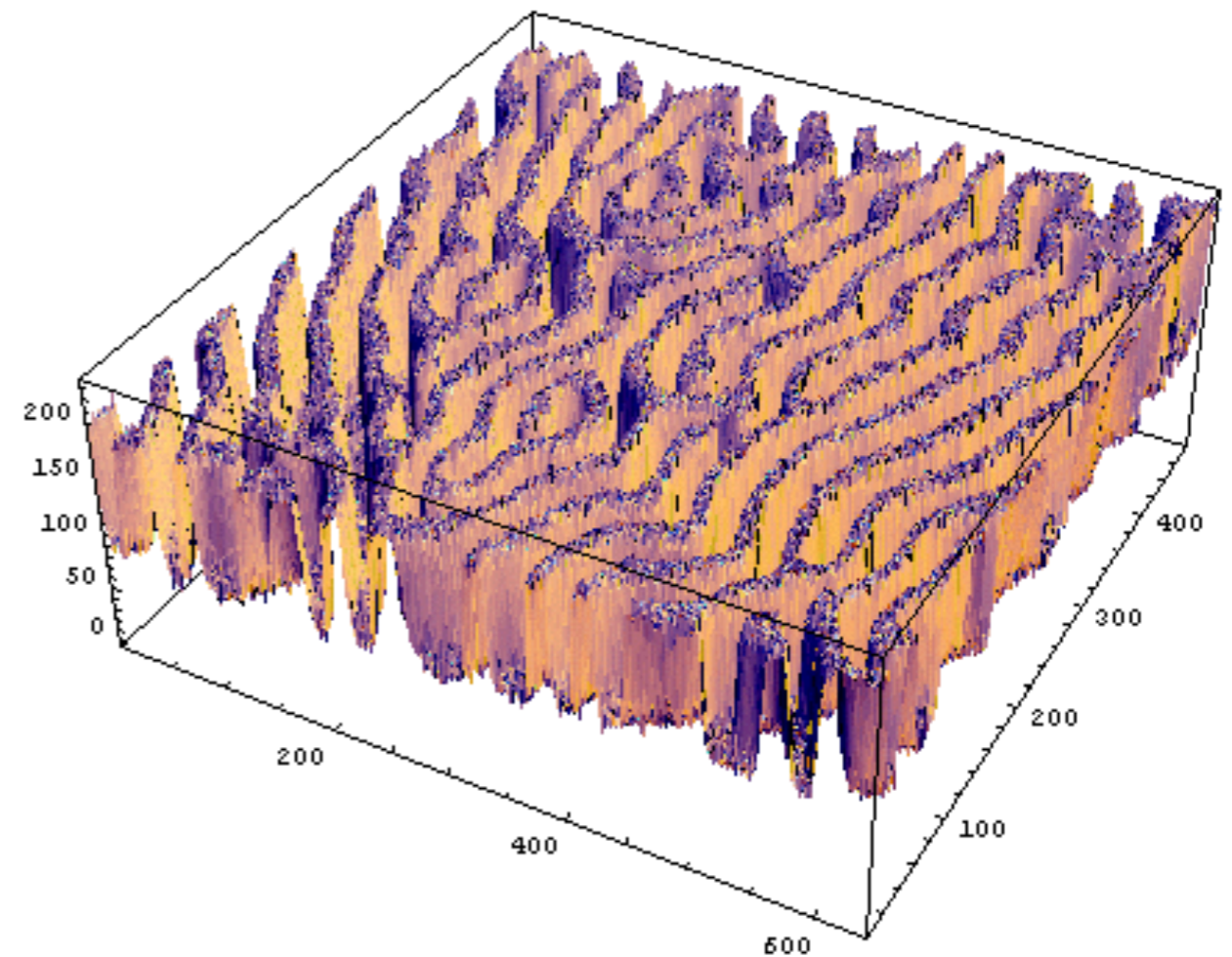
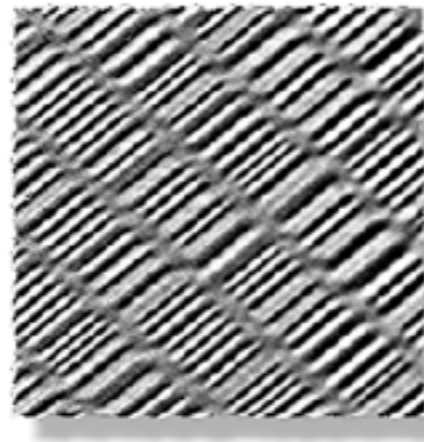
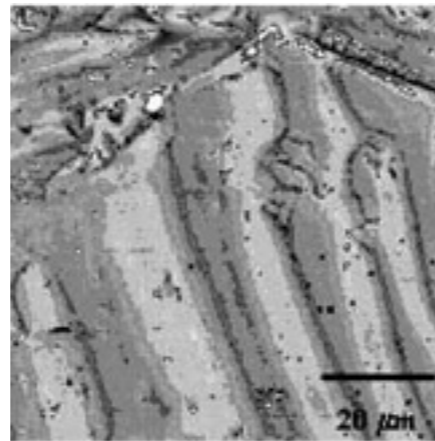
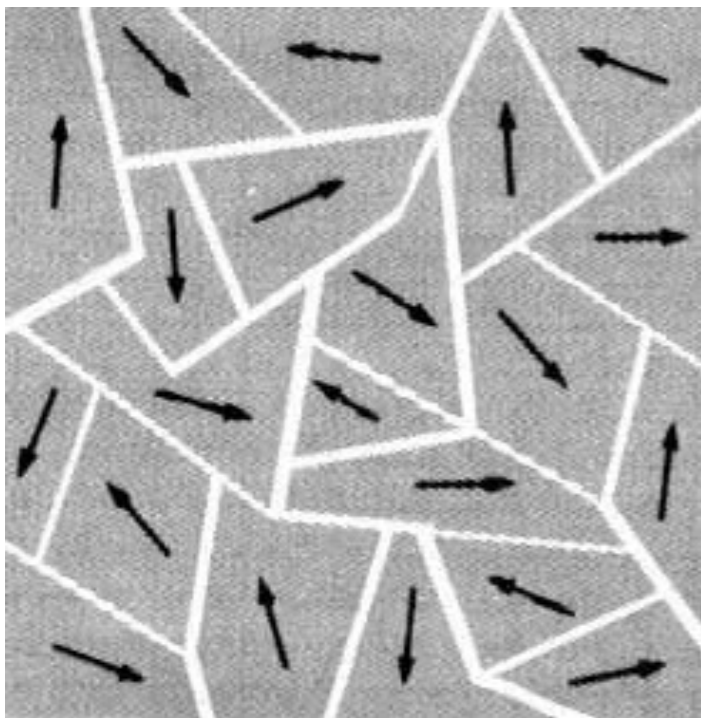


Momento  $\neq 0$

# Conceitos Iniciais

## Domínios magnéticos:

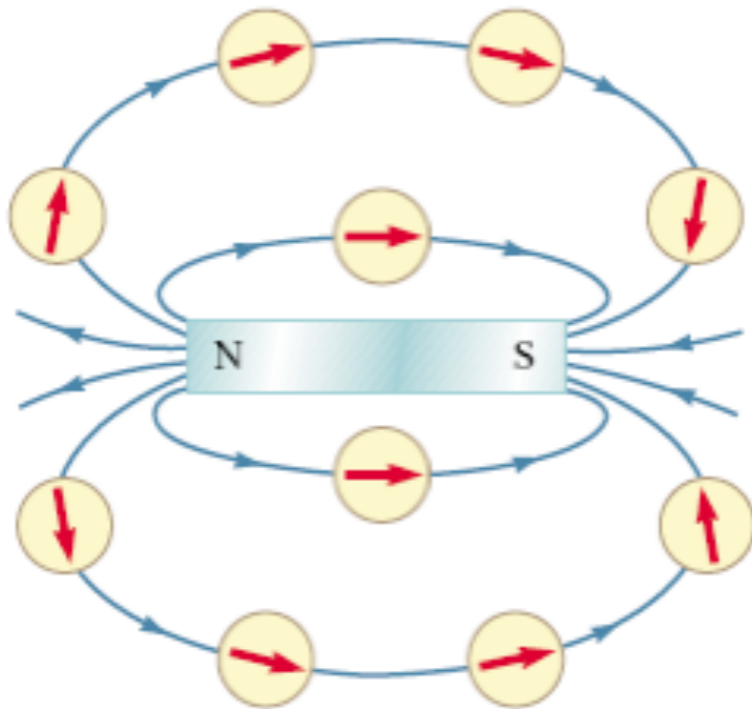
- Espaços de alinhamento unidirecional dos momentos magnéticos;
- Geralmente tem dimensões menores que 0,05 mm;
- Tem contornos identificáveis, similar aos grãos.



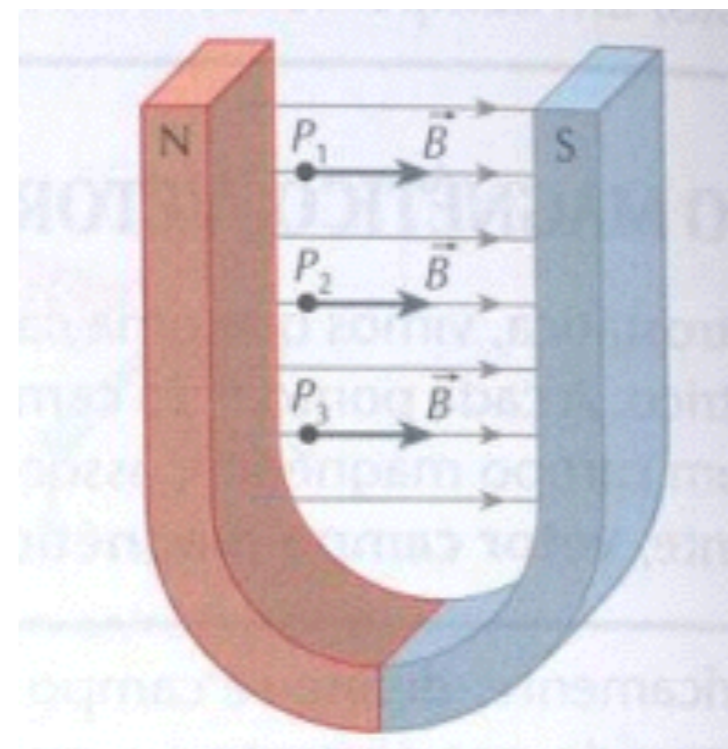
# Campo Magnético

## Linhas de campo magnético:

- São sempre linhas fechadas;
- Nunca se cruzam;
- Fora do imã, saem do norte e são orientadas para o sul;
- Dentro do imã tem orientação contrária;
- Saem e entram perpendicularmente à superfície do imã;
- Quanto maior a concentração das linhas, mais intenso é o campo.

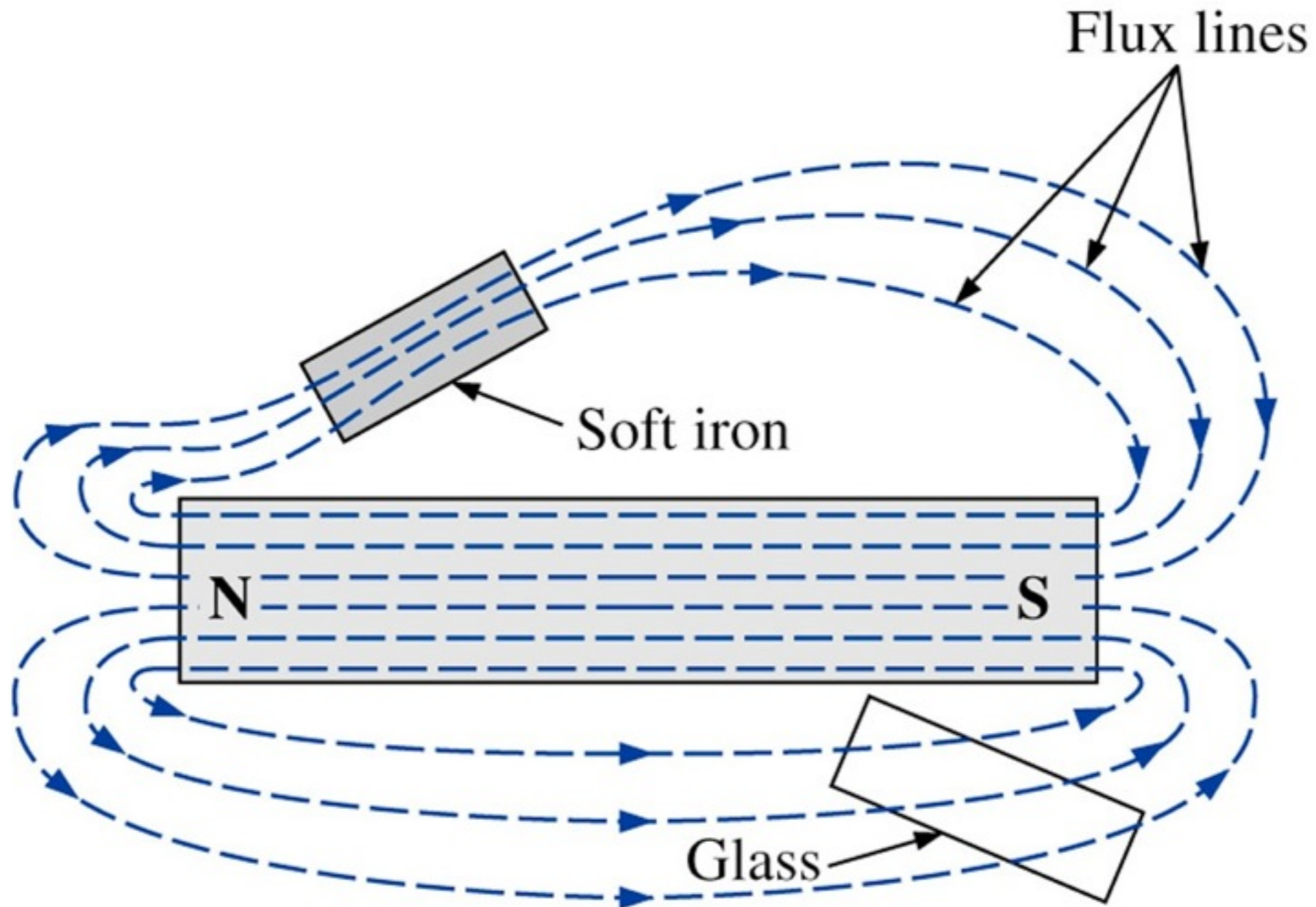


Campo não-uniforme



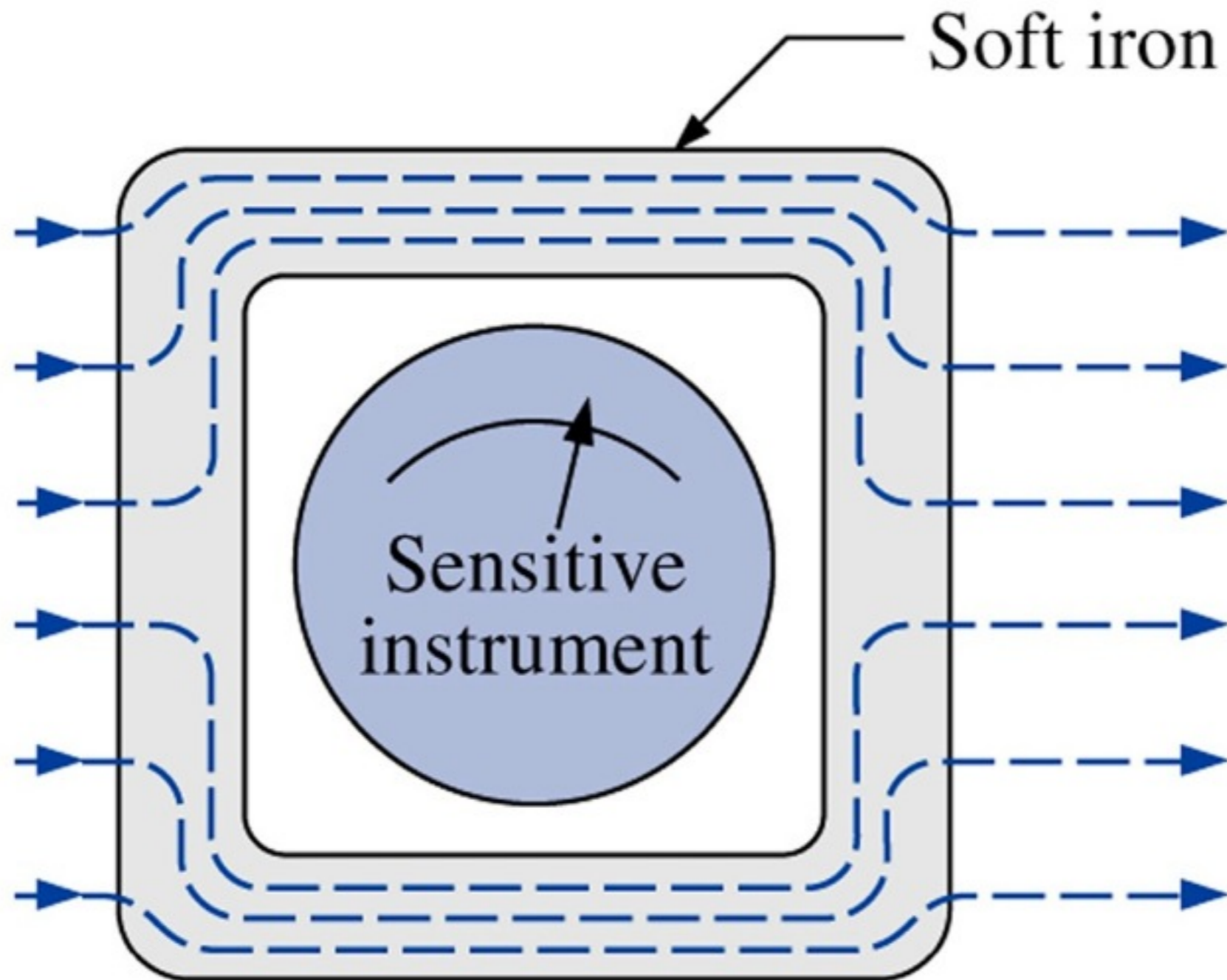
Campo uniforme

# Campo Magnético



Efeito de material ferromagnético sobre as linhas de campo.

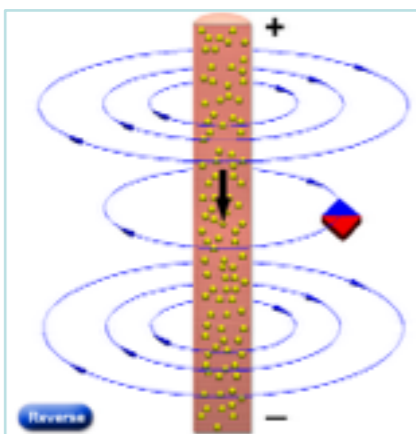
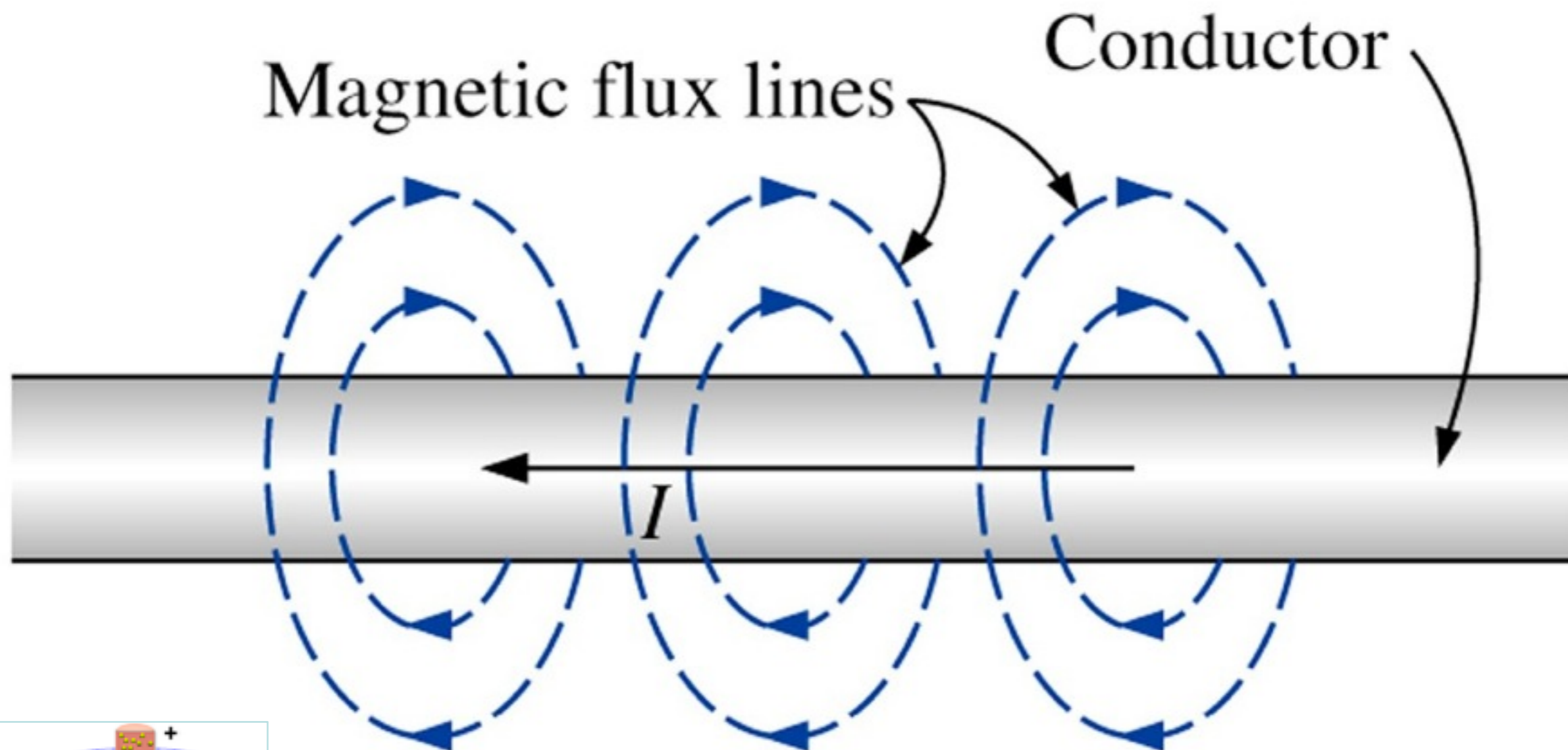
# Campo Magnético



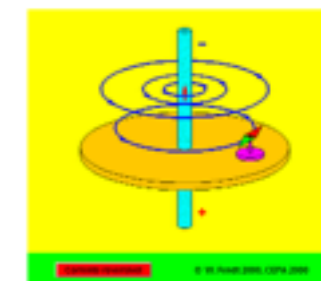
Efeito de material ferromagnético sobre as linhas de campo.

# Campo Magnético

Linhas de campo em um condutor retilíneo percorrido por corrente:

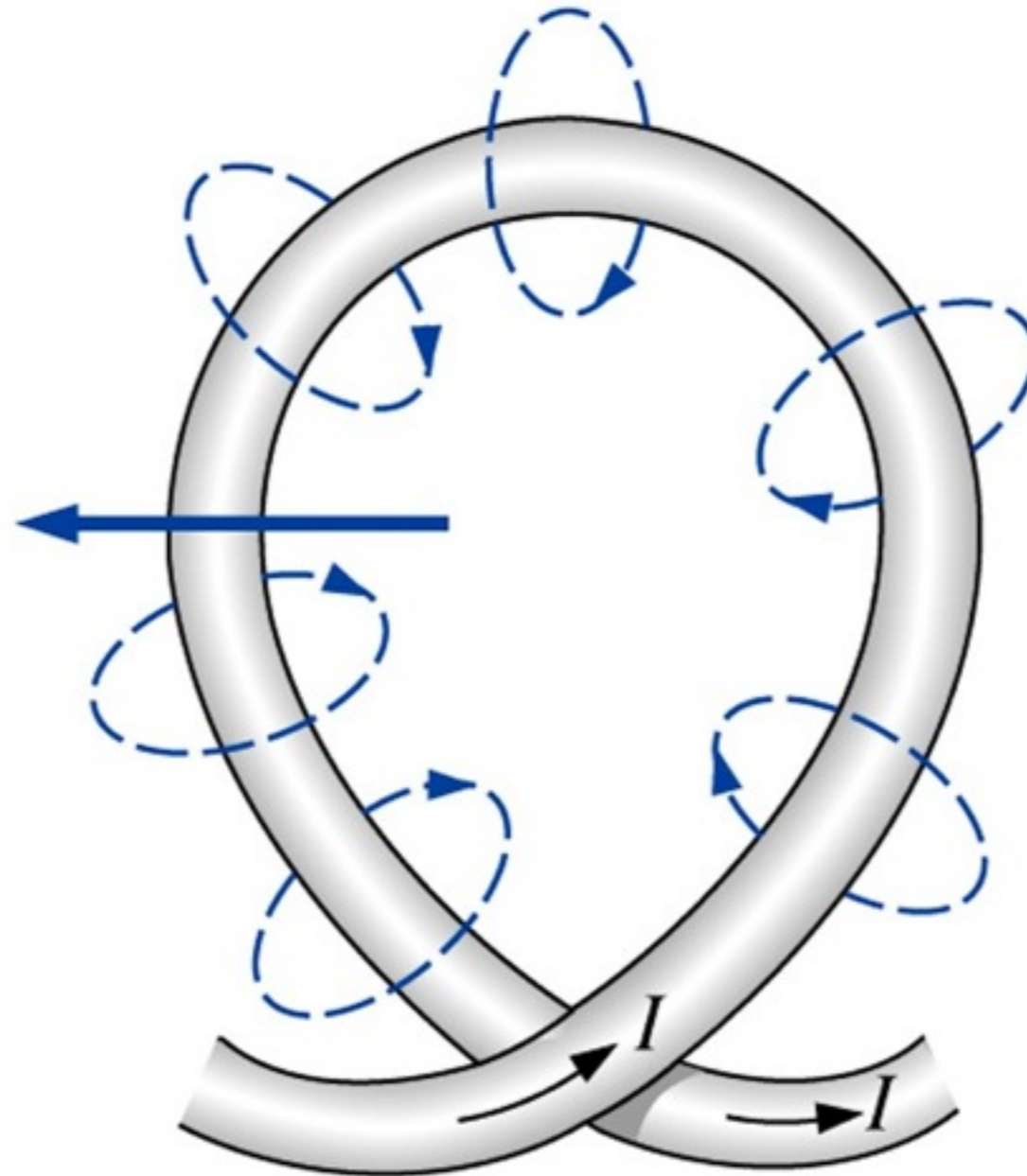


<http://www.walter-fendt.de/ph11br/>

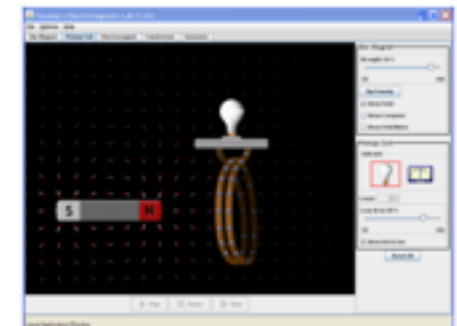


# Campo Magnético

Linhas de campo em uma espira circular percorrida por corrente:

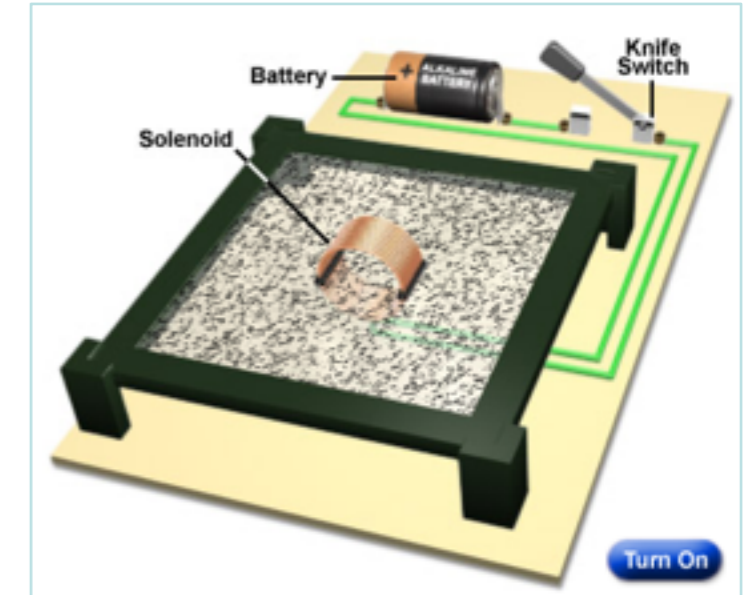
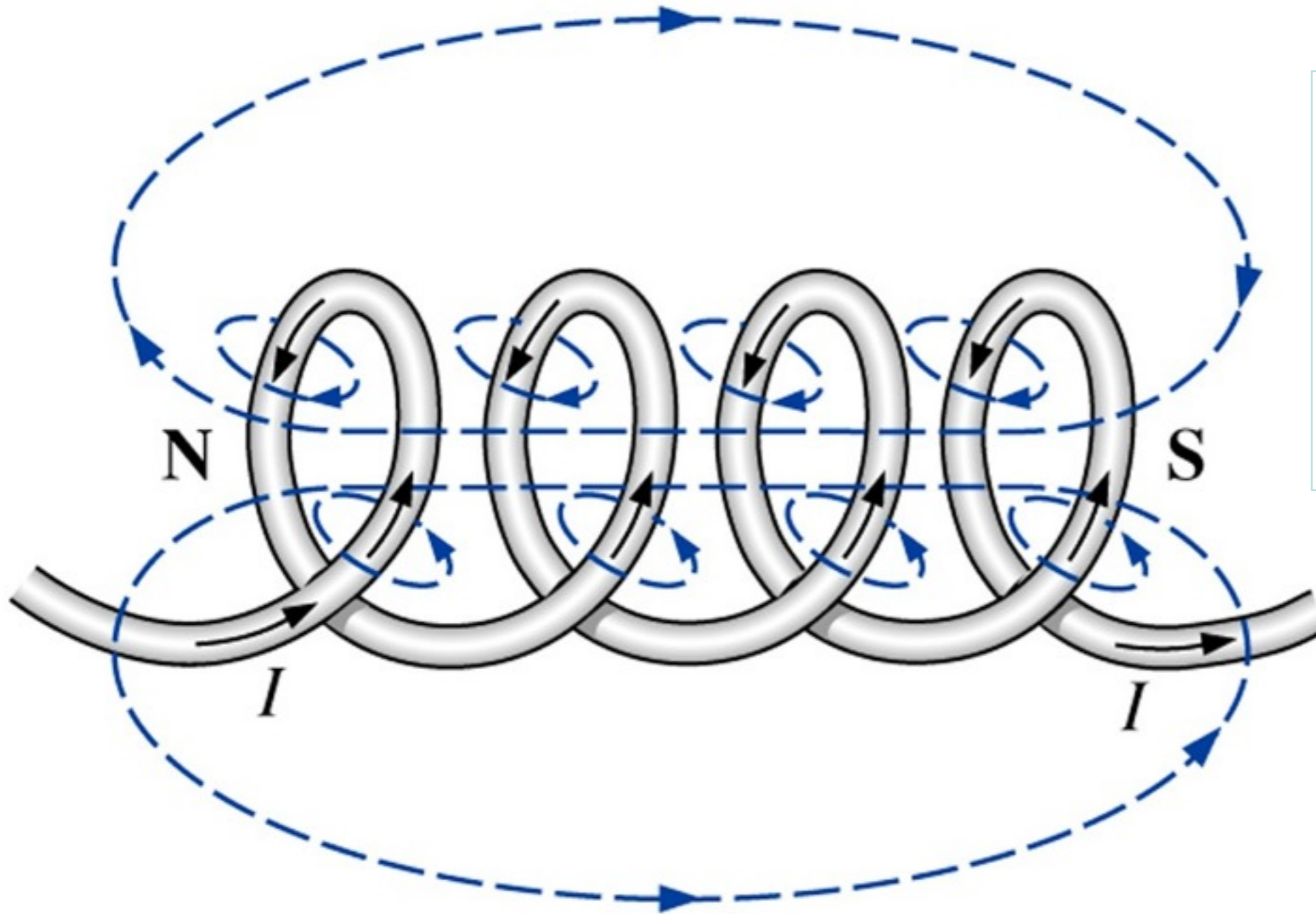


<http://phet.colorado.edu>



# Campo Magnético

Linhas de campo em uma bobina percorrida por corrente:



<http://www.magnet.fsu.edu>

# Densidade de Fluxo Magnético

## Densidade de fluxo magnético:

- Densidade de fluxo ( $B$ ) é número de linhas de campo por unidade de área.
- Unidade é Tesla [T];
- Um Tesla é igual a 1 Weber por metro quadrado de área.

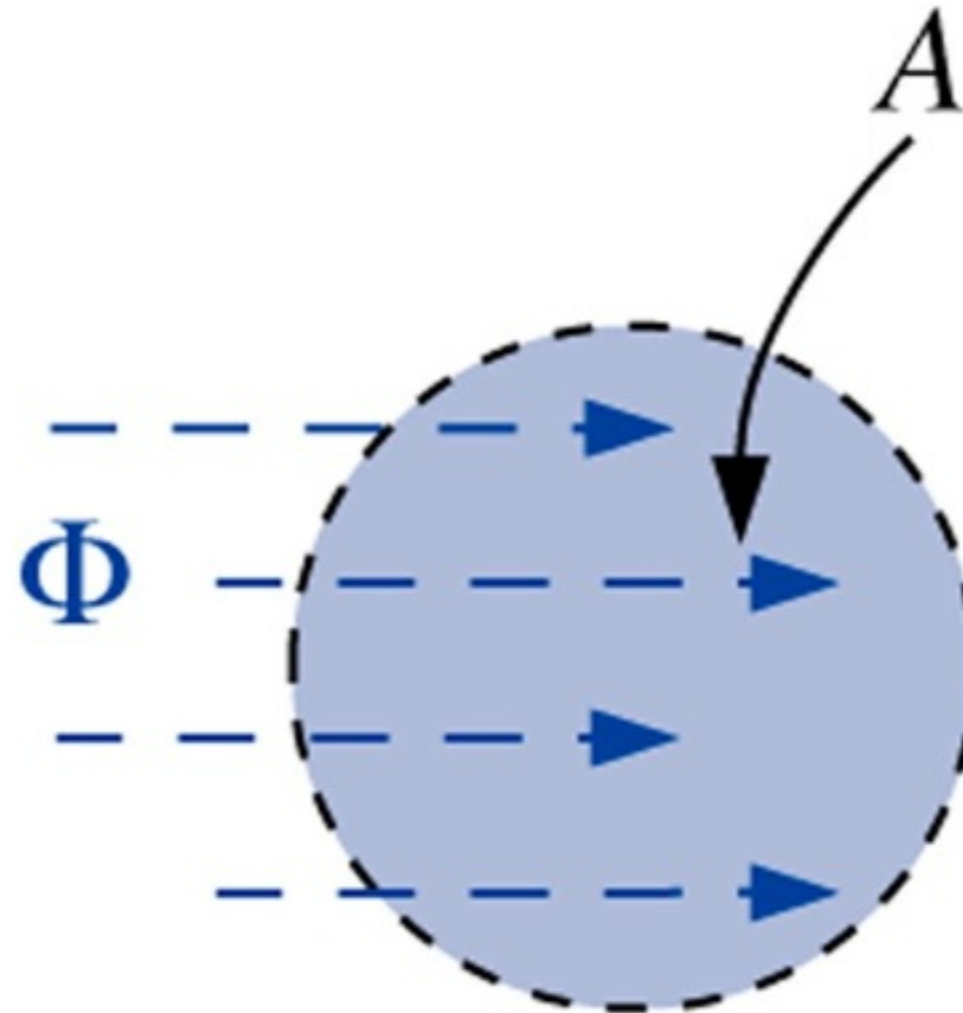
## Fluxo magnético:

- Fluxo ( $\varphi$ ) é o conjunto de todas as linhas de campo que atingem perpendicularmente uma área.
- Unidade é weber [Wb];
- Um Weber corresponde a  $1 \times 10^8$  linhas de campo.

# Densidade de Fluxo Magnético

$$B = \frac{\Phi}{A}$$

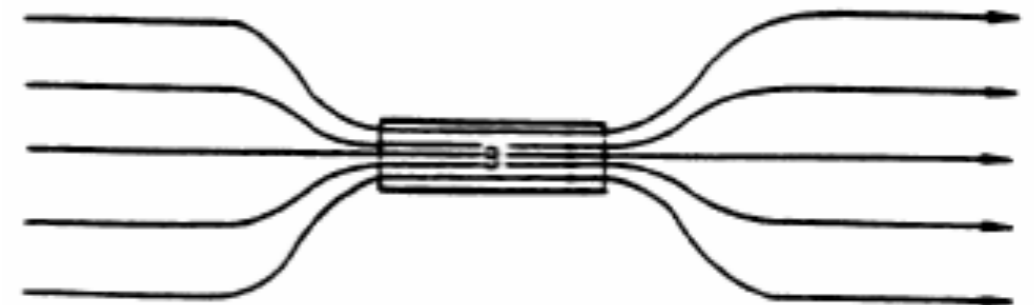
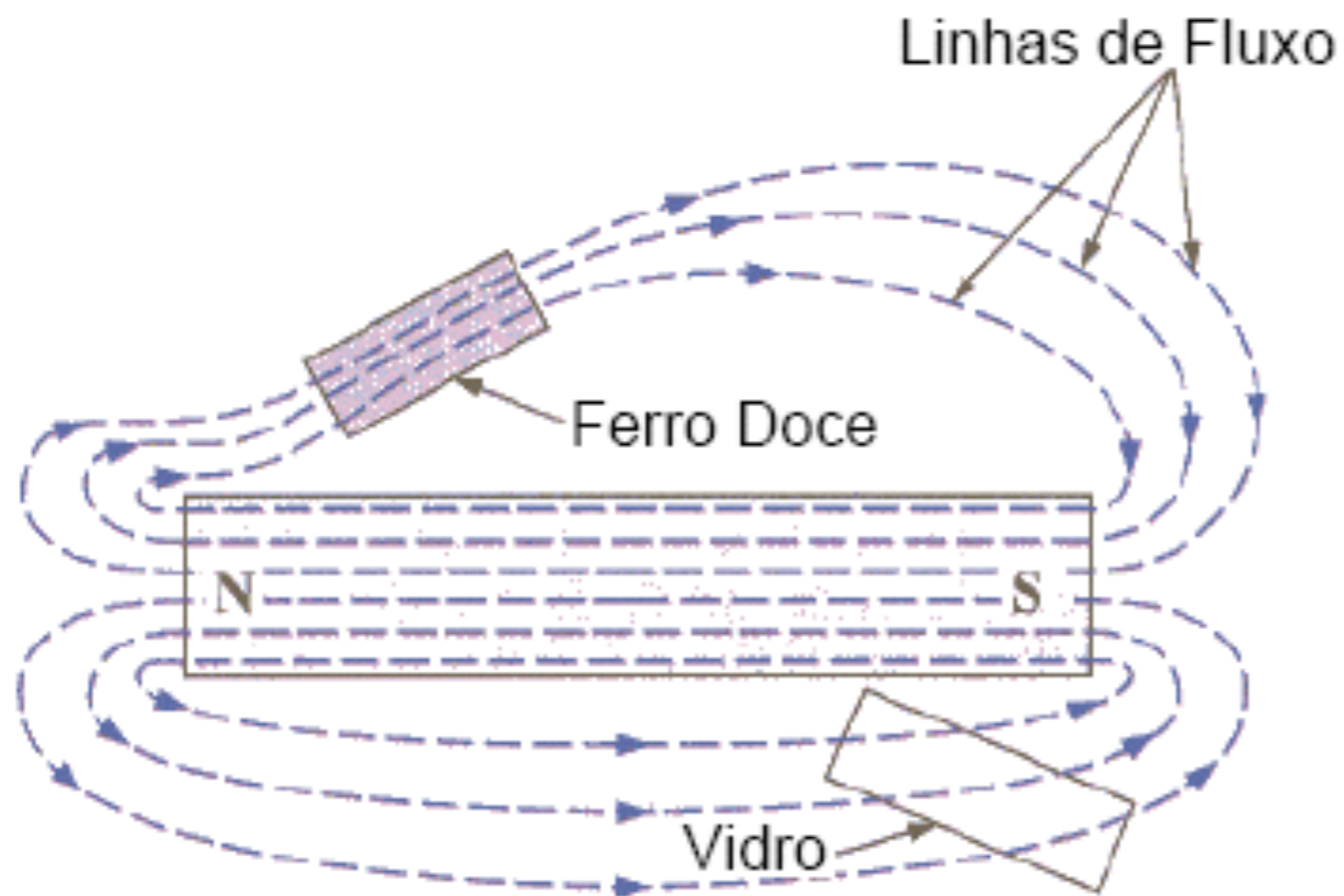
- B = teslas (T)
- $\Phi$  = webers (Wb)
- A = metros quadrados ( $m^2$ )



# Permeabilidade Magnética

## Permeabilidade magnética:

- Grau de magnetização de um material em resposta ao campo magnético;
- Facilidade de "conduzir" o fluxo magnético;
- Simbolizado pela letra  $\mu$ .



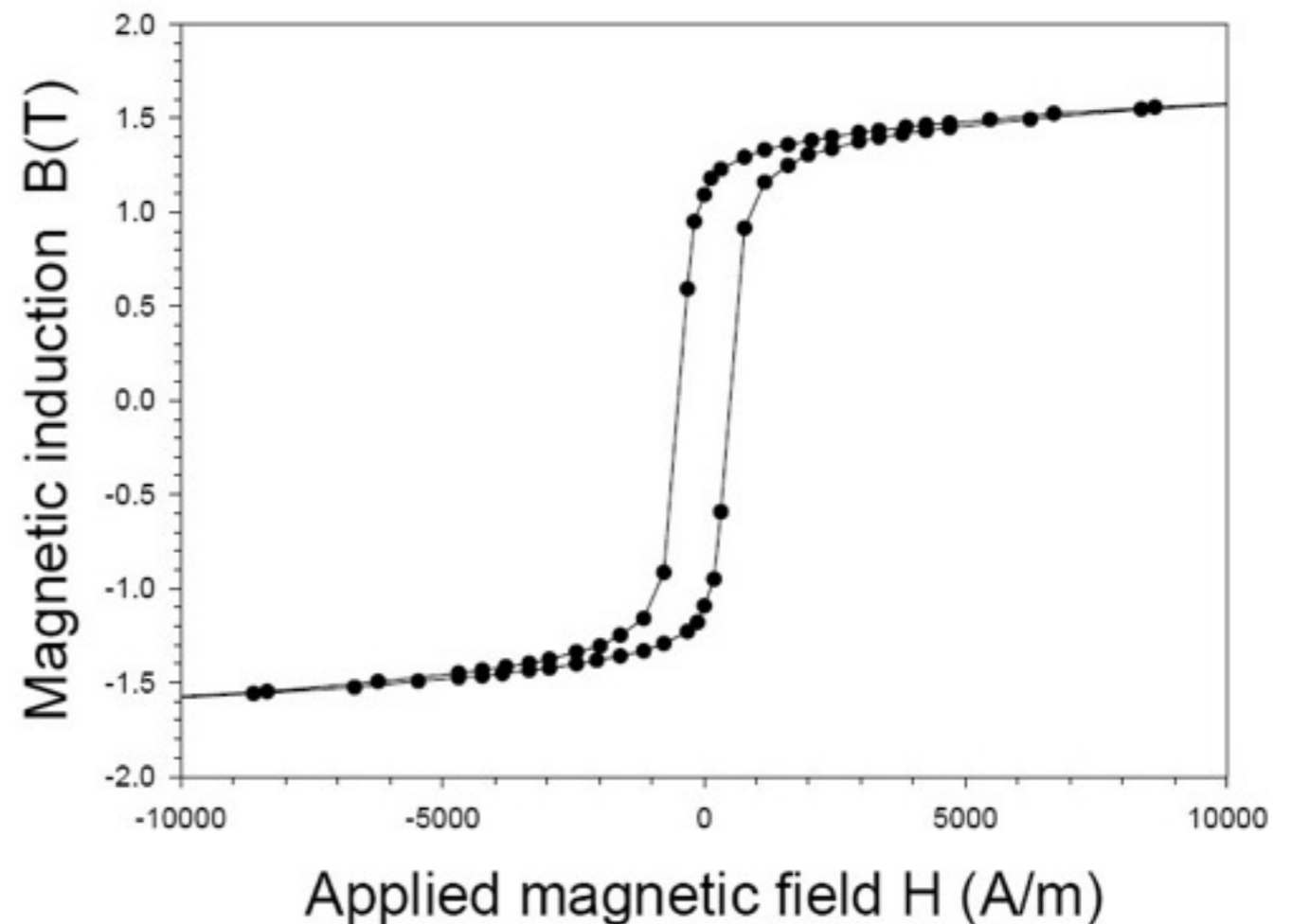
# Permeabilidade Magnética

$$\mu = \frac{B}{H} \longrightarrow \text{Permeabilidade absoluta}$$

$$\mu_r = \frac{\mu}{\mu_o} \longrightarrow \text{Permeabilidade relativa}$$

$$\mu_o = 4\pi \cdot 10^{-7} \frac{Wb}{A/m}$$

Permeabilidade do vácuo



# Permeabilidade Magnética

Permeabilidade Relativa, $\mu_R$	Tipo de Material
$\gg 1$	Ferromagnéticos
$\cong 1$	Paramagnéticos
$< 1$	Diamagnéticos

Tipo de Material	Permeabilidade Relativa, $\mu_R$
Ferro Comercial	9.000
Ferro Purificado	200.000
Ferro Silício	55.000
Permalloy	$1 \times 10^6$
Supermalloy	$1 \times 10^7$
Permendur	5.000
Ferrite	2.000

# Força Magnetizante

Relação entre os vetores densidade de campo magnético e campo magnético indutor:

$$H = \frac{\mathfrak{S}}{l} \quad \longrightarrow \quad H = \frac{NI}{l}$$

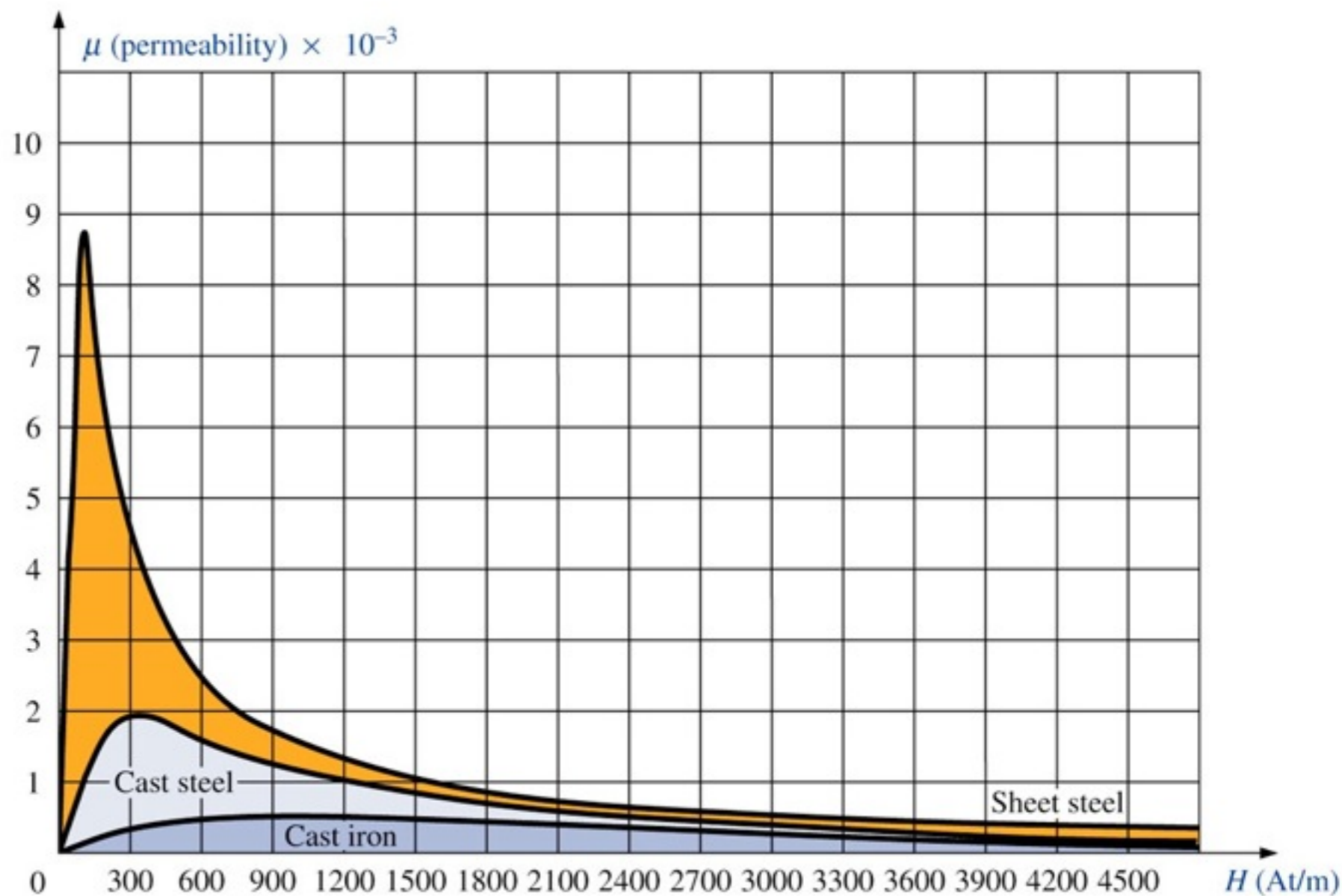
- $H$  = força magnetizante (A/m)
- $\mathfrak{S}$  = força magnetomotriz (A/Wb)
- $l$  = comprimento (m)

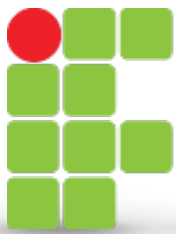
# Força Magnetizante

Relação densidade de fluxo e força magnetizante:

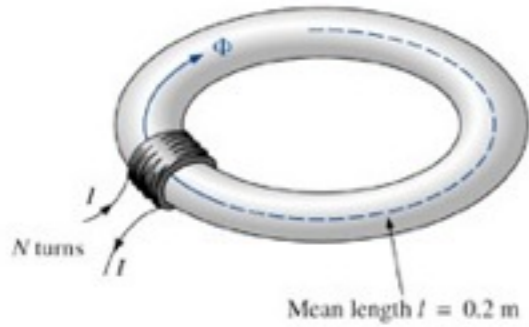
$$B = \mu H$$

Variação de  $\mu$  com  
a força magnetizante

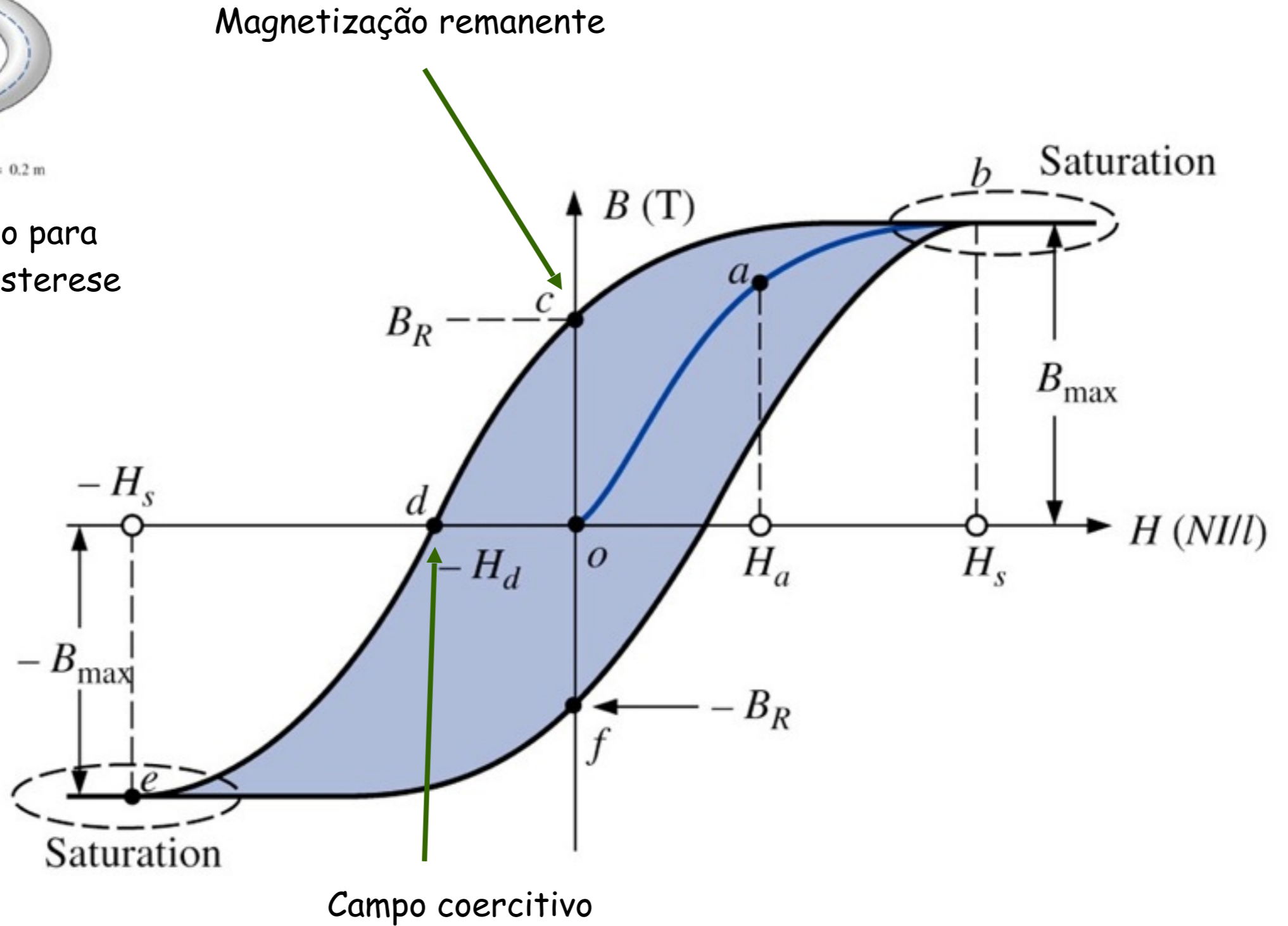




# Histerese



Circuito magnético para obter a curva de histerese



# Perdas Magnéticas

## Correntes parasitas:

- Induzidas no núcleo, devido ao mesmo ser, normalmente, de material ferromagnético.

## Perdas por histerese:

- Trabalho realizado pelo campo (H) para obter o fluxo (B);
- Expressa a dificuldade que o campo (H) terá para orientar os domínios de um material ferromagnético.

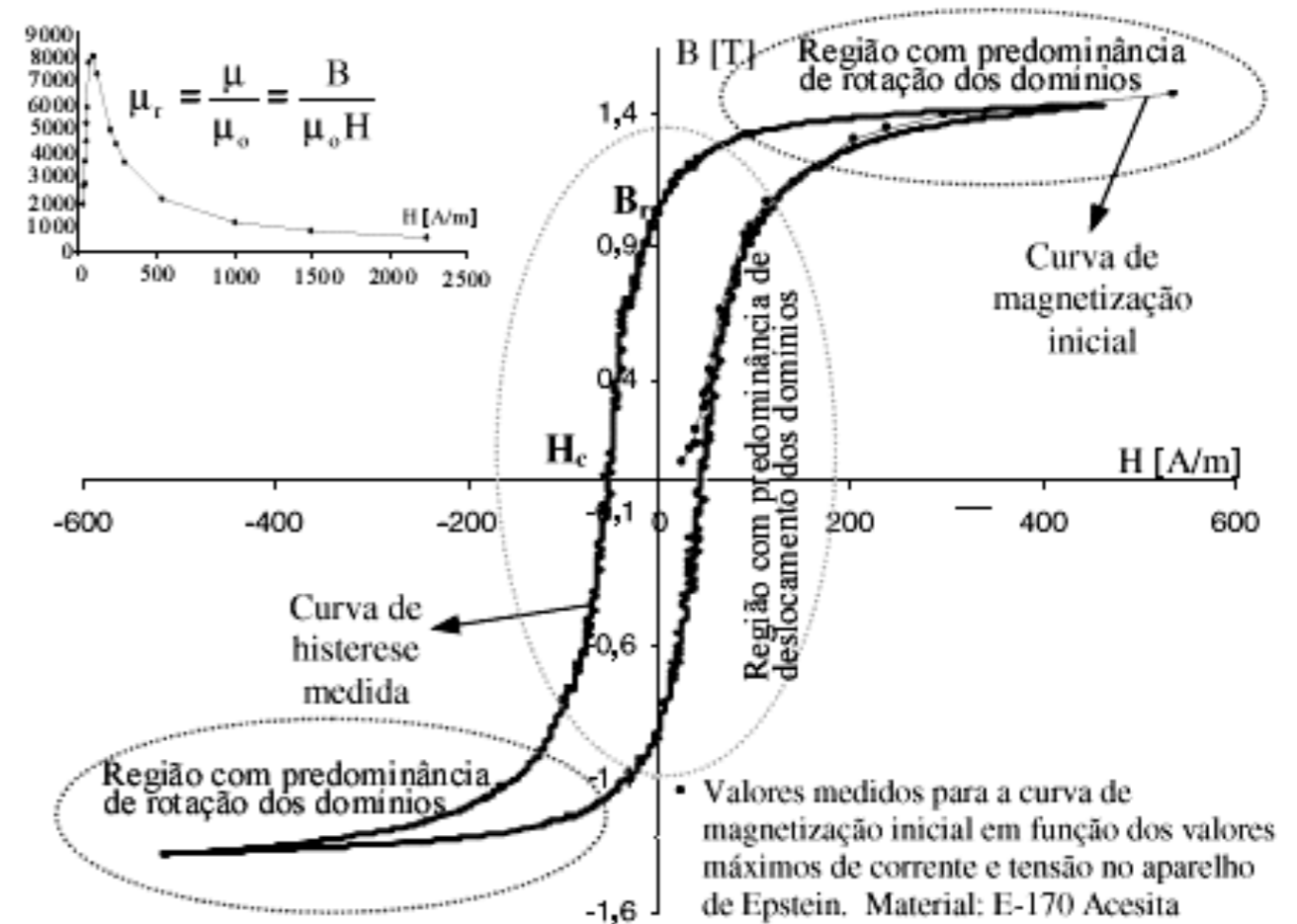


Figura 1: Curva representativa da histerese medida à 1Hz.

# Efeitos de Proximidade e Pelicular

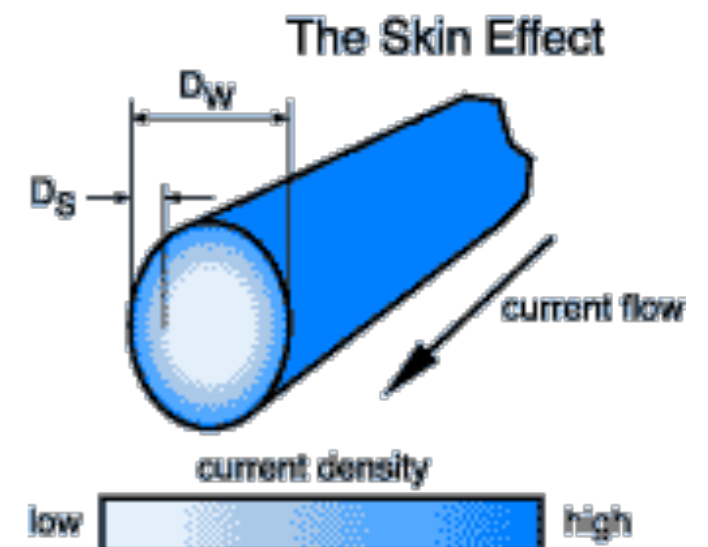
## Efeito de proximidade:

-Relaciona um aumento na resistência em função dos campos magnéticos produzidos pelos demais condutores colocados nas adjacências.

## Efeito pelicular (efeito skin):

-Restringe a secção do condutor para frequências elevadas.  
-Em altas frequências, a tensão oposta induzida se concentra no centro do condutor, resultando em uma corrente maior próxima à superfície do condutor e uma rápida redução próxima do centro.

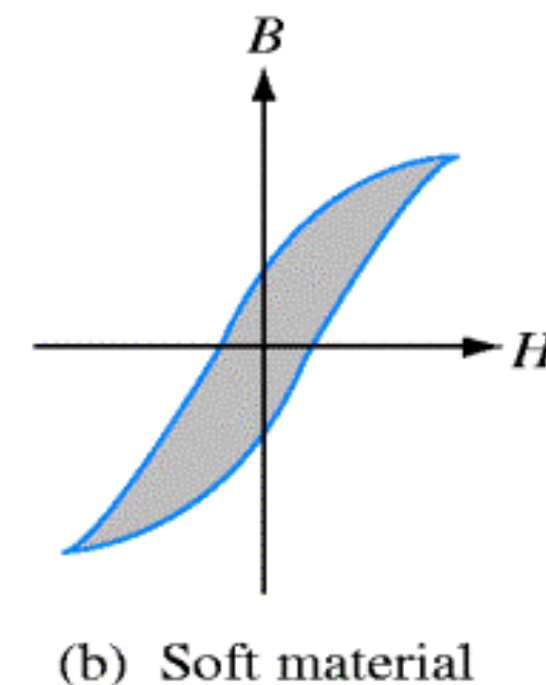
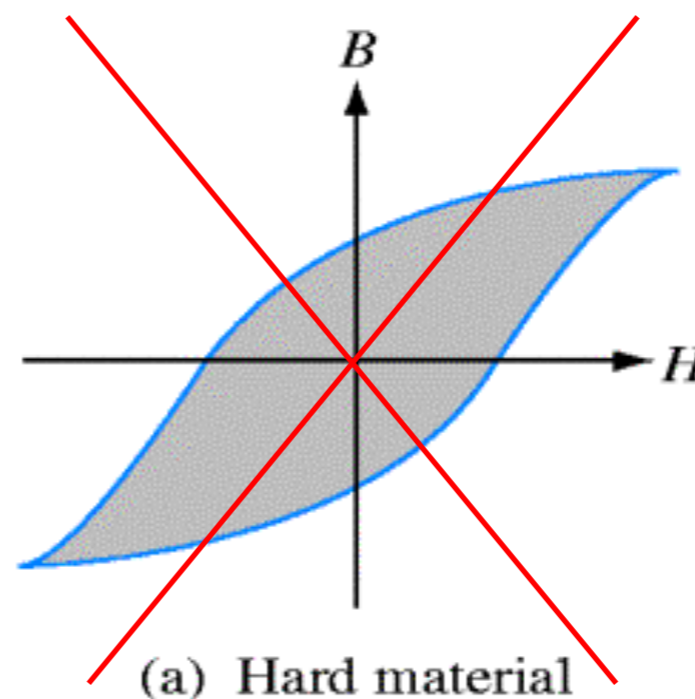
Profundidade de penetração  $\longrightarrow$   $\Delta = \frac{7,5}{\sqrt{f_s}} [cm]$



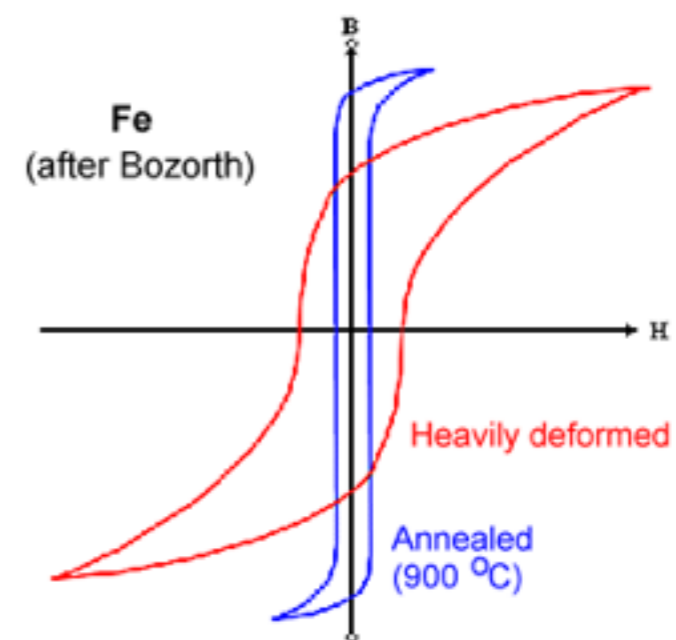
# Materiais Magnéticos Moles

Característica geral:

- Não apresentam magnetismo remanente.



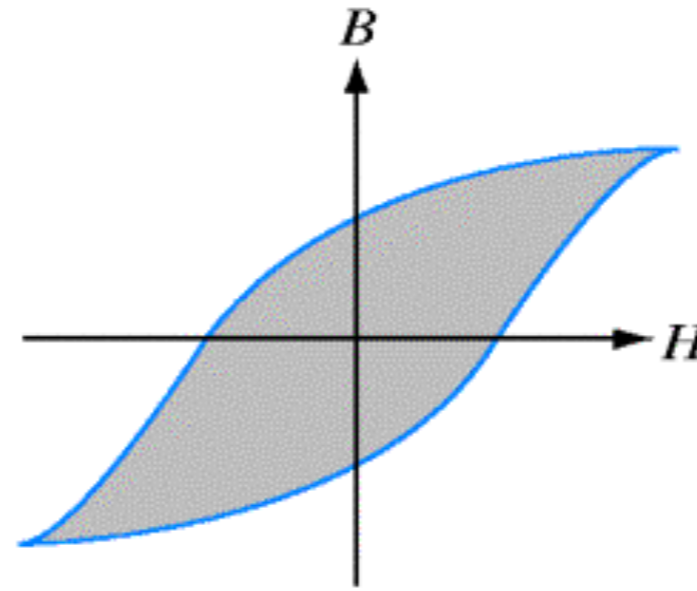
Recozimento →



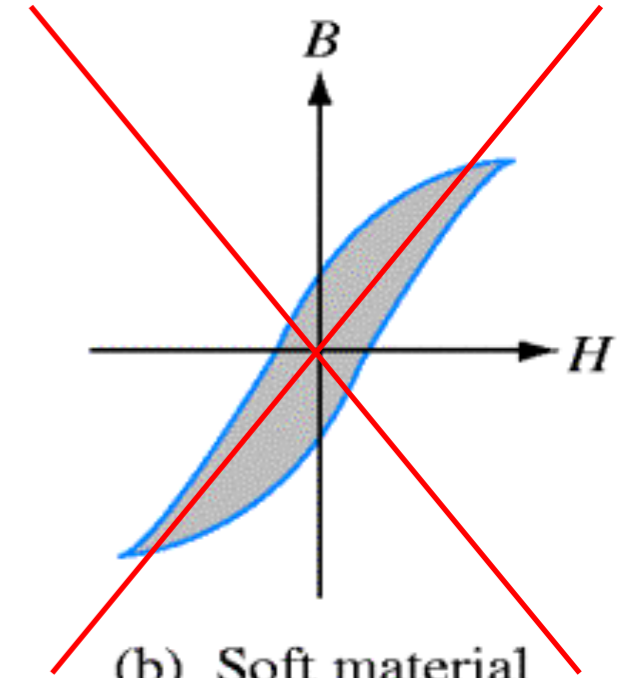
# Materiais Magnéticos Duros

## Característica geral:

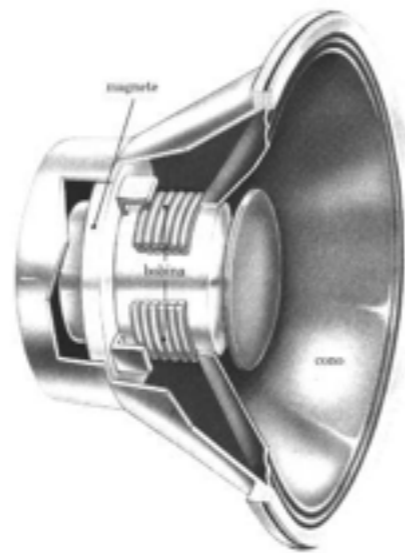
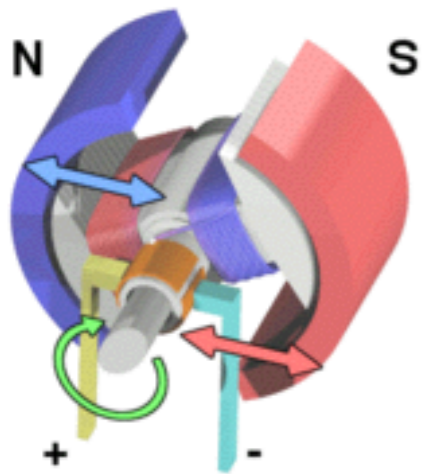
- Apresentam elevado magnetismo remanente.



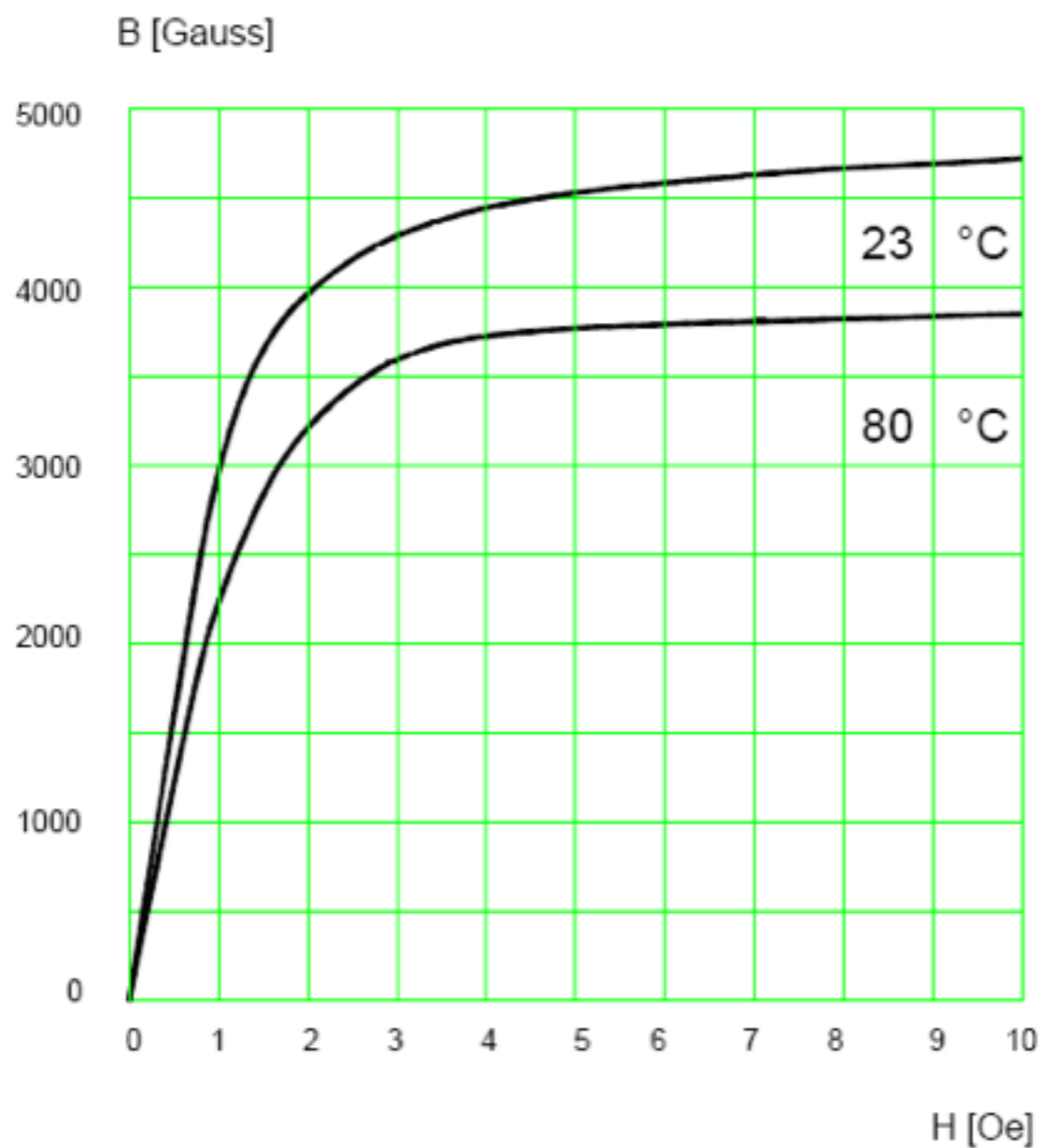
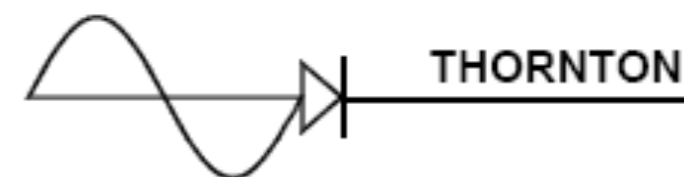
(a) Hard material



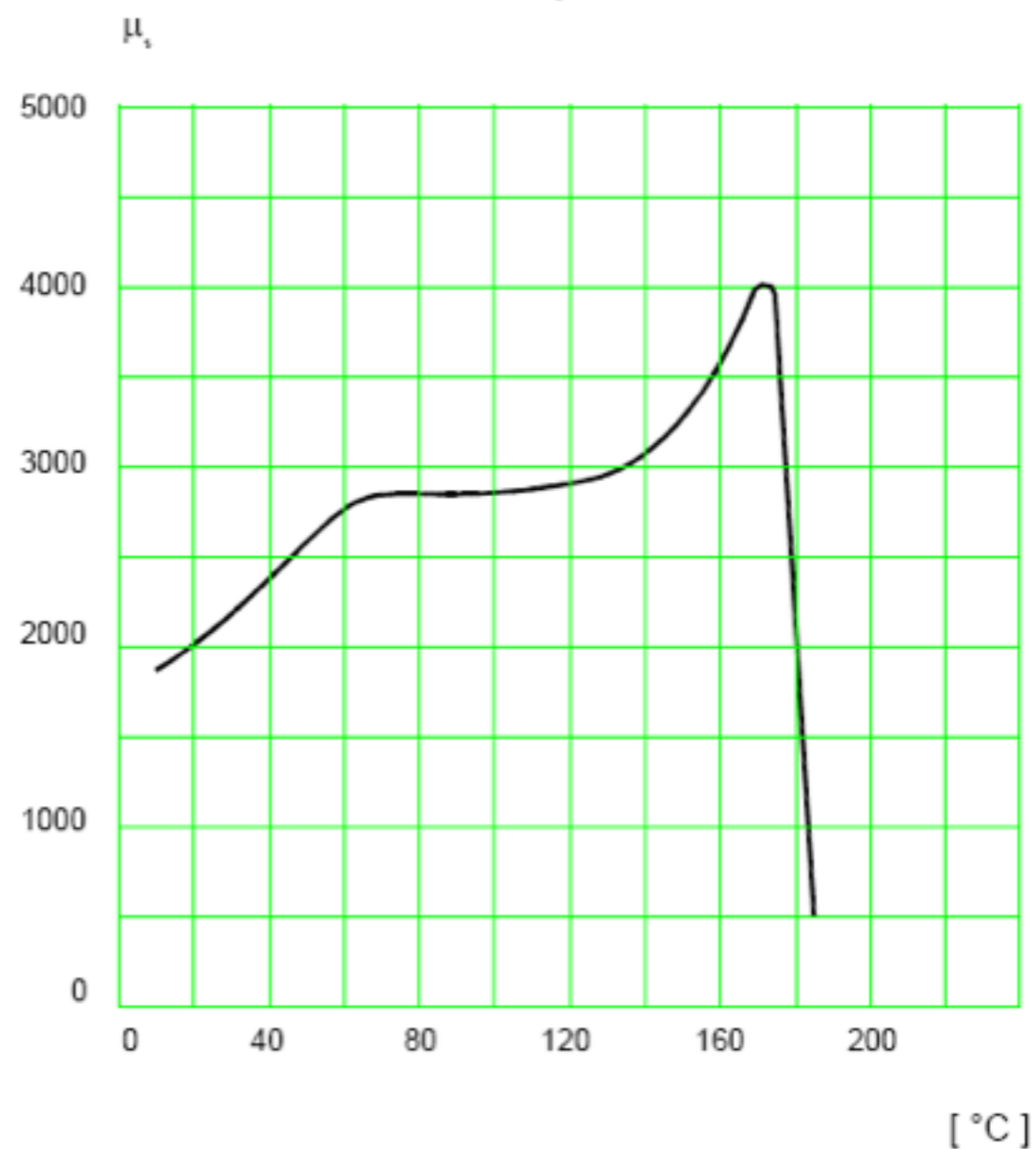
(b) Soft material



# Permeabilidade versus Temperatura



Típico B x H



$\mu_s$  x Temperatura

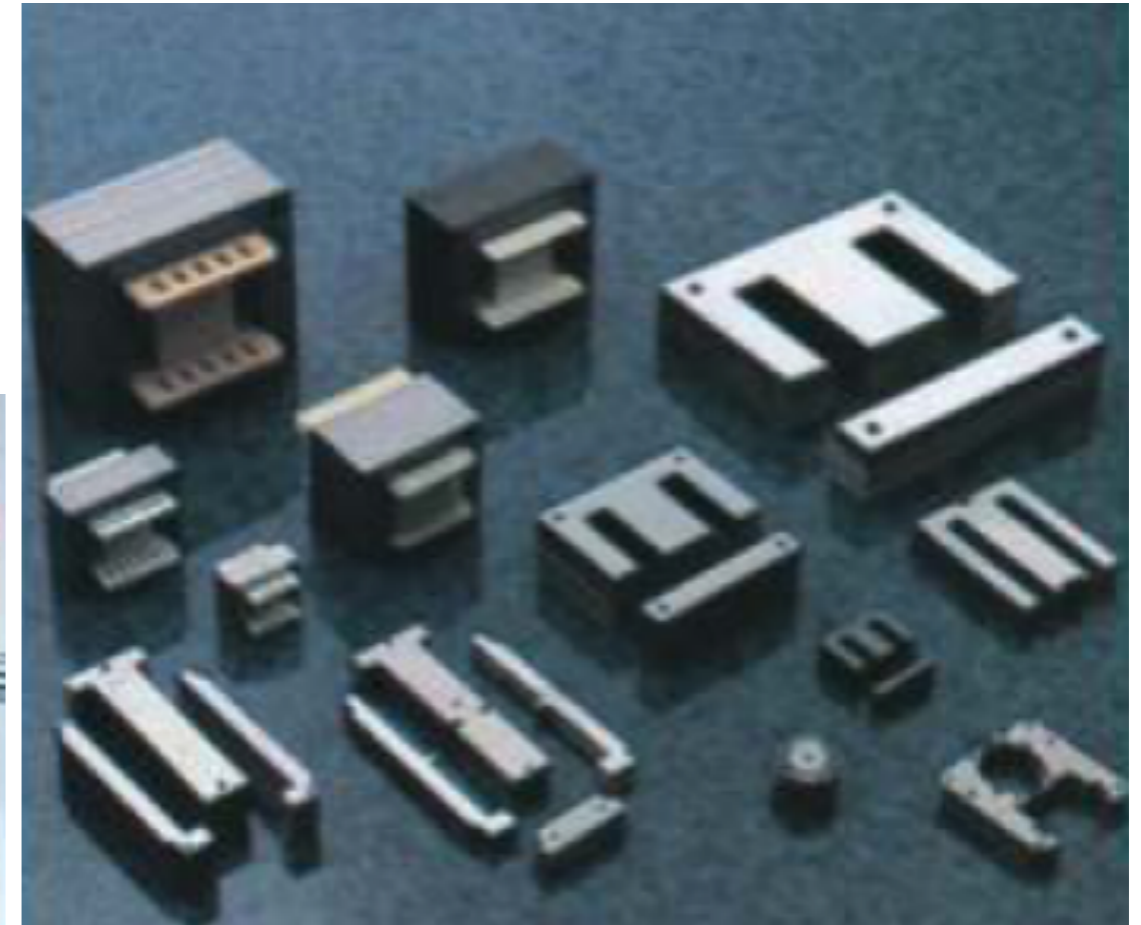
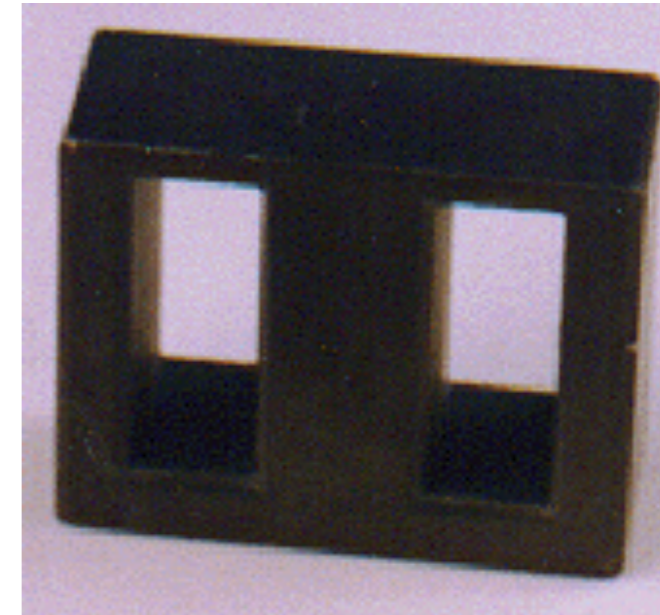
# Núcleos Magnéticos

## Perdas magnéticas:

- Por correntes de Foucault;
- Perda por histerese.

## Perdas dependem de:

- Metalurgia do material;
- Porcentagem de silício;
- Frequência;
- Espessura do material;
- Indução magnética máxima.



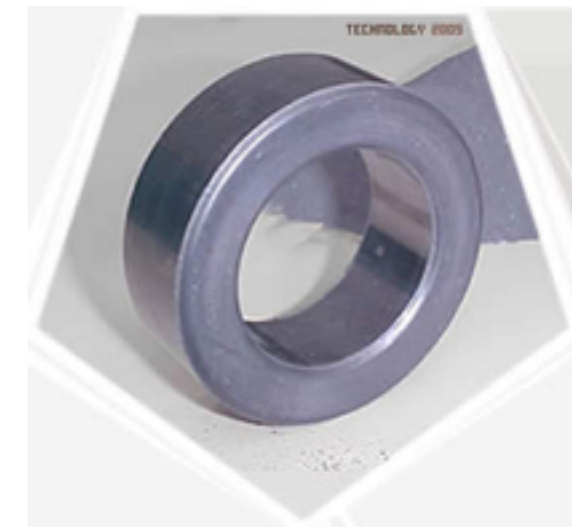
# Núcleos Magnéticos

## Núcleos:

- Laminados
  - Ferro - silício de grão não orientado;
  - Ferro - silício de grão orientado.
- Compactados
  - Ferrites;
  - Pós metálicos.



# Núcleos Magnéticos

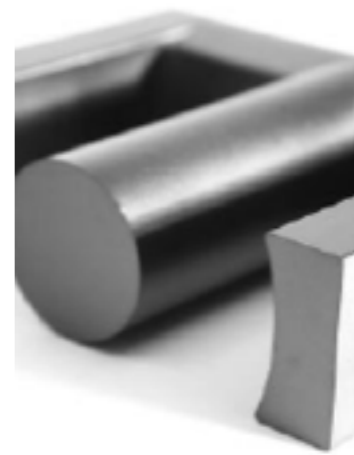
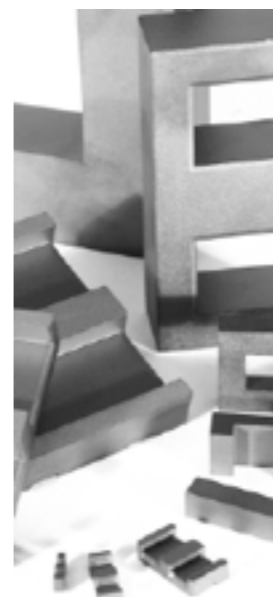
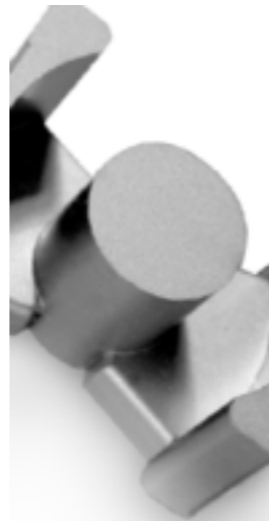


# Núcleos Magnéticos

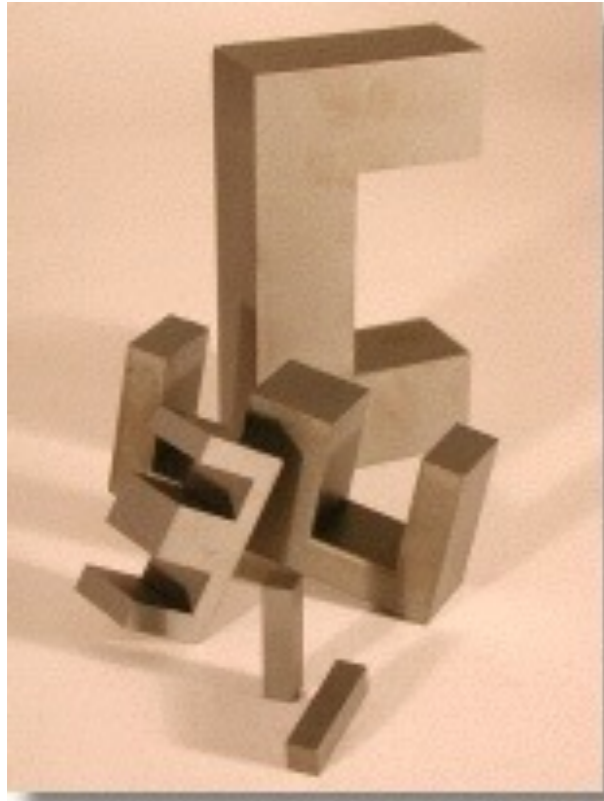


TABLE 1: FERRITE CORE COMPARATIVE GEOMETRY CONSIDERATIONS

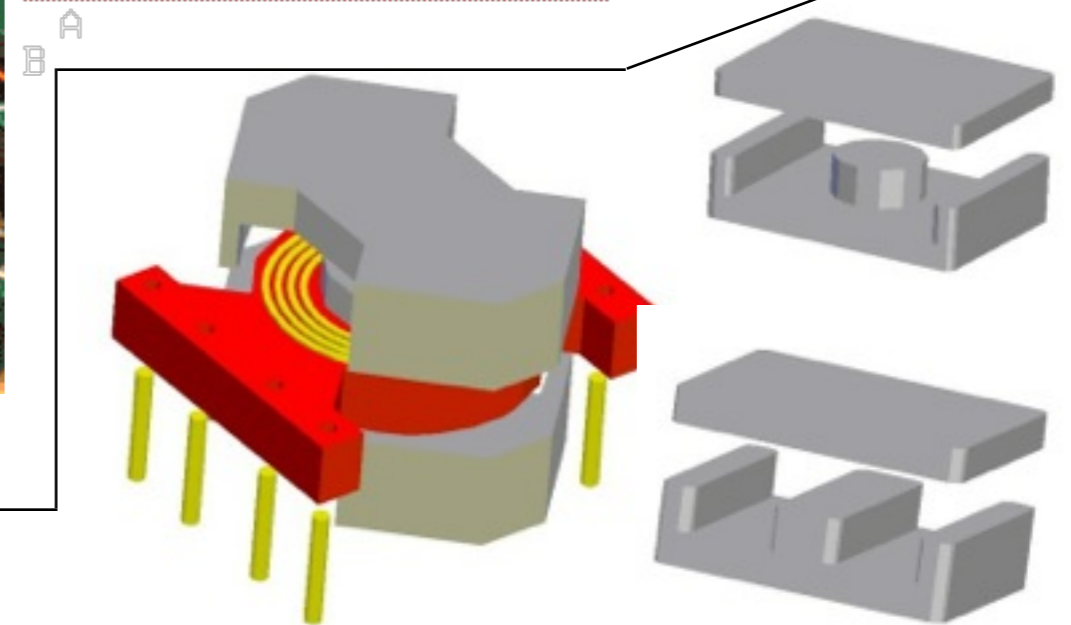
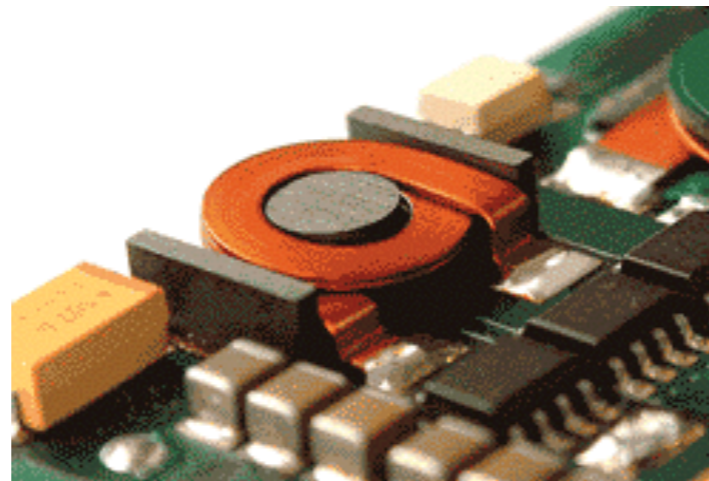
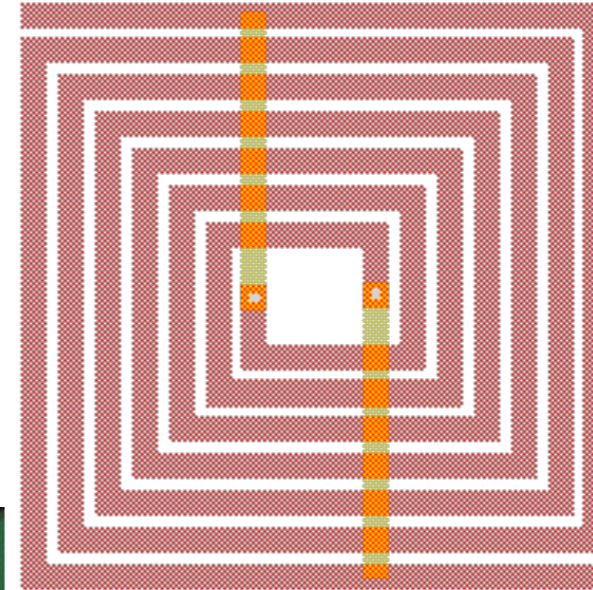
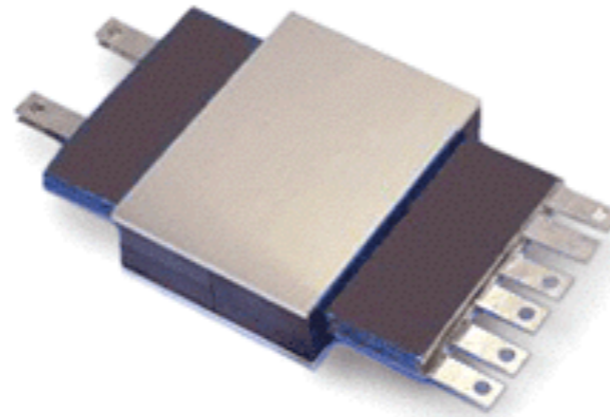
	POT CORES	DOUBLE SLAB, RM CORES	EP CORES	PQ CORES	E CORES	E <sub>C</sub> , ETD, EER, ER CORES	TOROIDS
See Catalog Section	6	7-8	9	10	11	12	13
Core Cost	High	High	Medium	High	Low	Medium	Very Low
Bobbin Cost	Low	Low	High	High	Low	Medium	None
Winding Cost	Low	Low	Low	Low	Low	Low	High
Winding Flexibility	Good	Good	Good	Good	Excellent	Excellent	Fair
Assembly	Simple	Simple	Simple	Simple	Simple	Medium	None
Mounting Flexibility**	Good	Good	Good	Fair	Good	Fair	Poor
Heat Dissipation	Poor	Good	Poor	Good	Excellent	Good	Good
Shielding	Excellent	Good	Excellent	Fair	Poor	Poor	Good



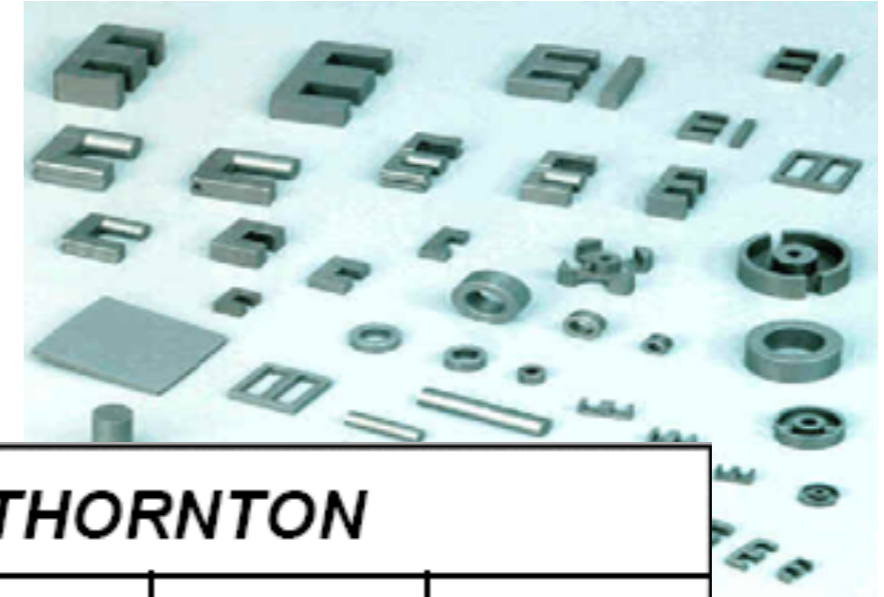
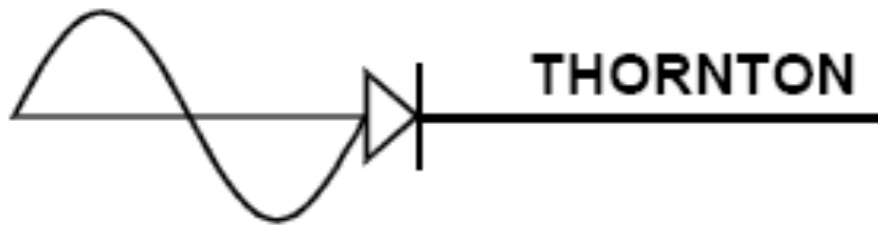
# Núcleos Magnéticos



Núcleos planares

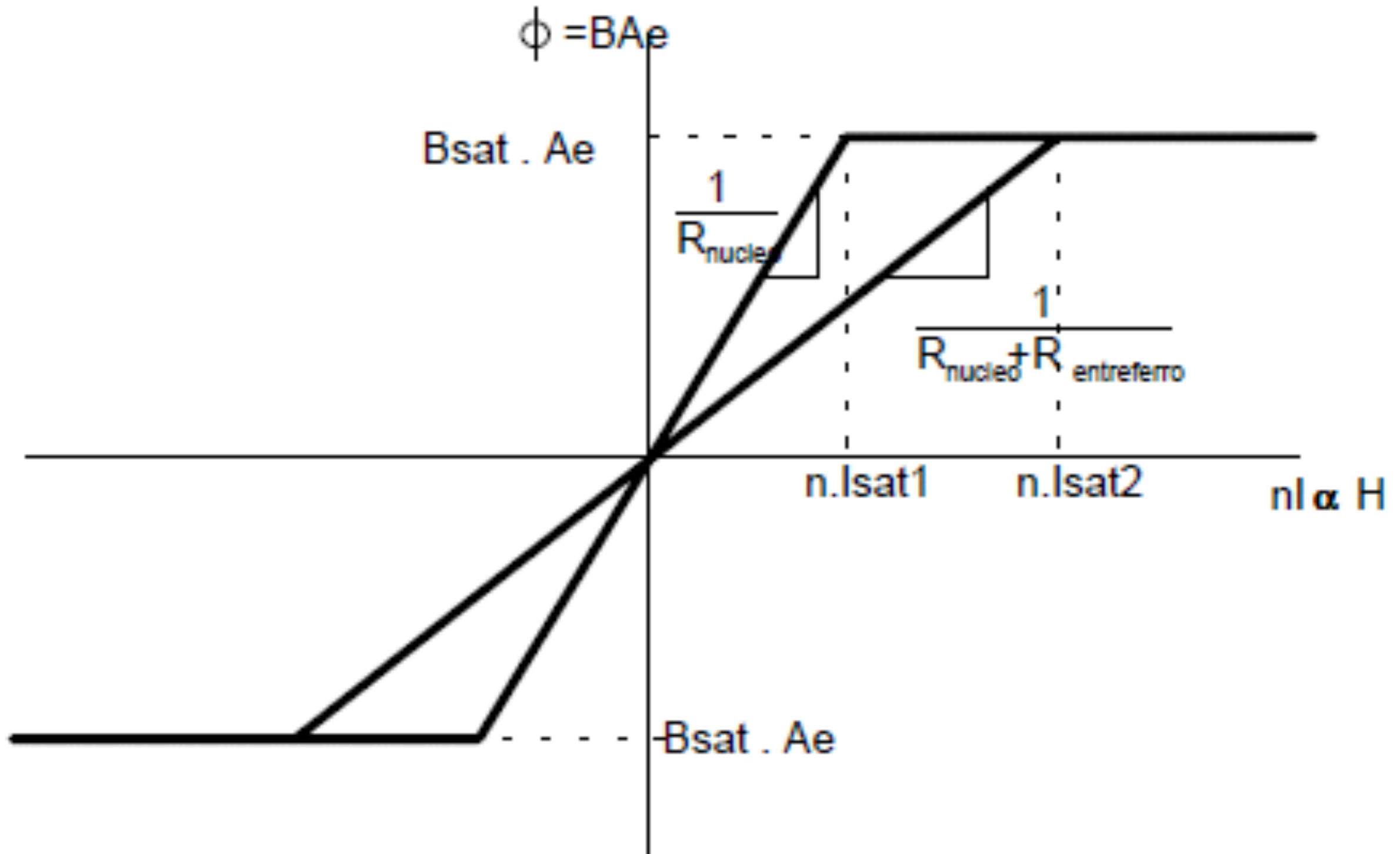


# Núcleos Magnéticos



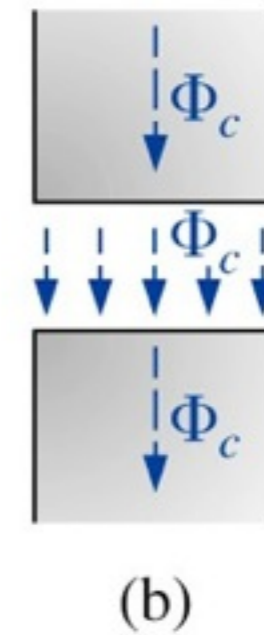
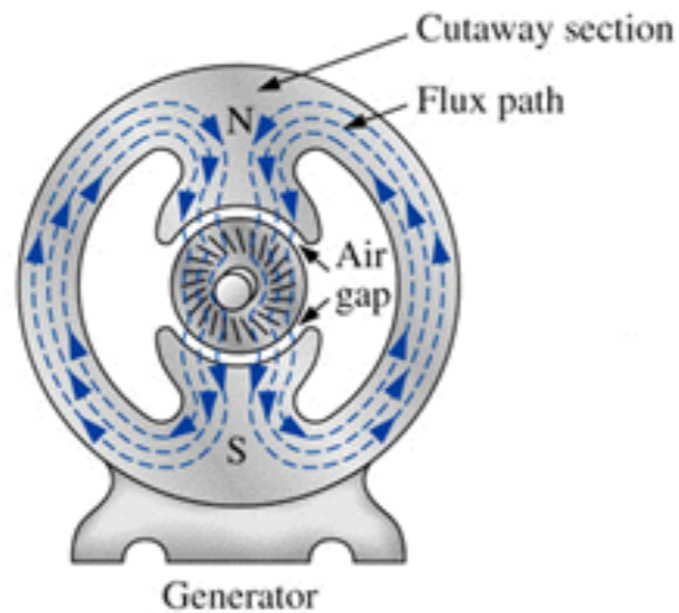
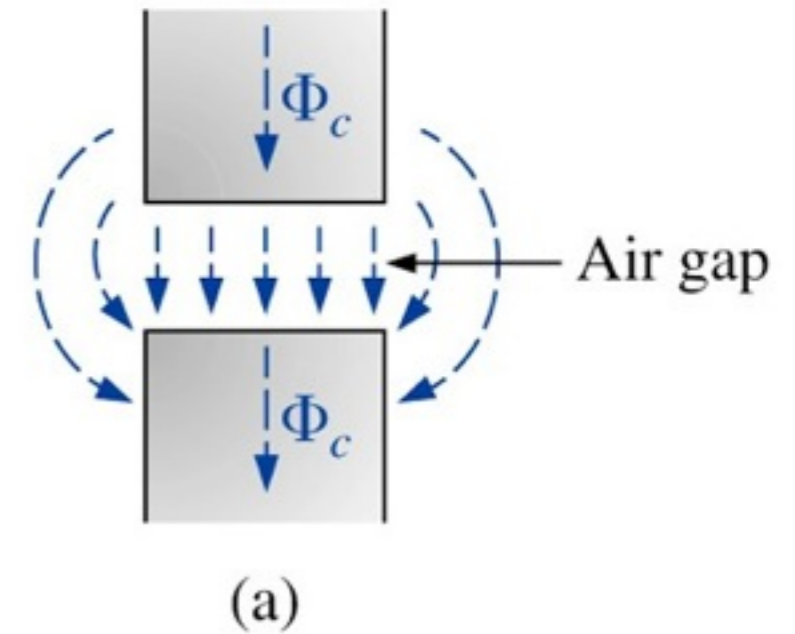
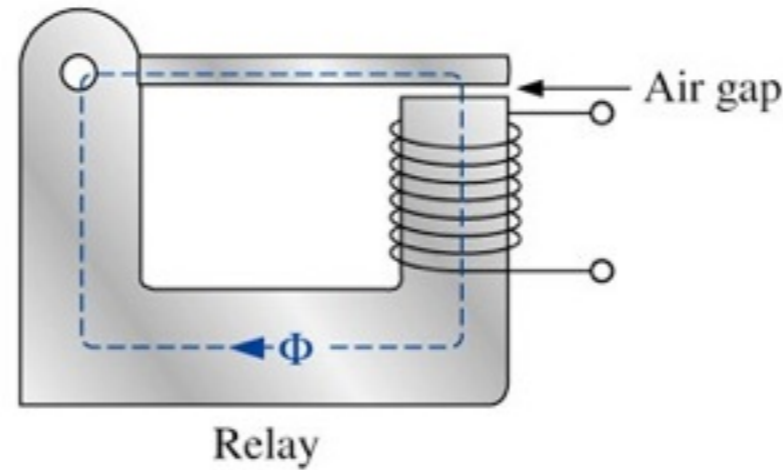
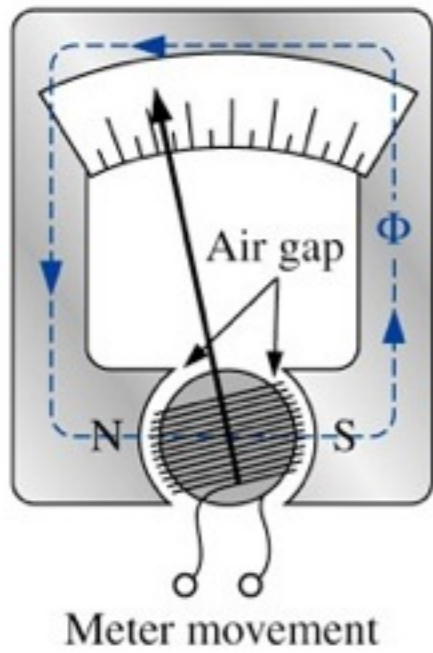
<b>CARACTERÍSTICAS DOS MATERIAIS THORNTON</b>				
Material		IP 6	IP 12R	IP12E
Permeabilidade Inicial $\mu_i$		2000 $\pm$ 25%	2100 $\pm$ 25%	2300 $\pm$ 25%
Fator de Dissipação (Rel.)	$f = 10$ [ KHz ]	-----	-----	-----
$\tan \delta / \mu_i \cdot 10^{-6}$	$f = 100$ [ KHz ]	-----	-----	-----
Temperatura de Curie	[ °C ]	$\geq 165$	$\geq 210$	$\geq 210$
Coercividade	[ A/m ]	18.0	18.0	18.0
Densidade de Fluxo ( $B$ ) a 15 Oe, 23 °C	[ $10^{-3}$ T ]	480	510	510
Constante de Histerese ( $\eta_B$ )	[ $10^{-3}$ / T ]	$\leq 8.0$	-----	-----
Fator de desacomodação ( $D_f$ )	[ ppm ]	10.0	-----	-----
Densidade ( $\rho$ )	[ Kg/m <sup>3</sup> ]	4800	4800	4800

# Entreferros

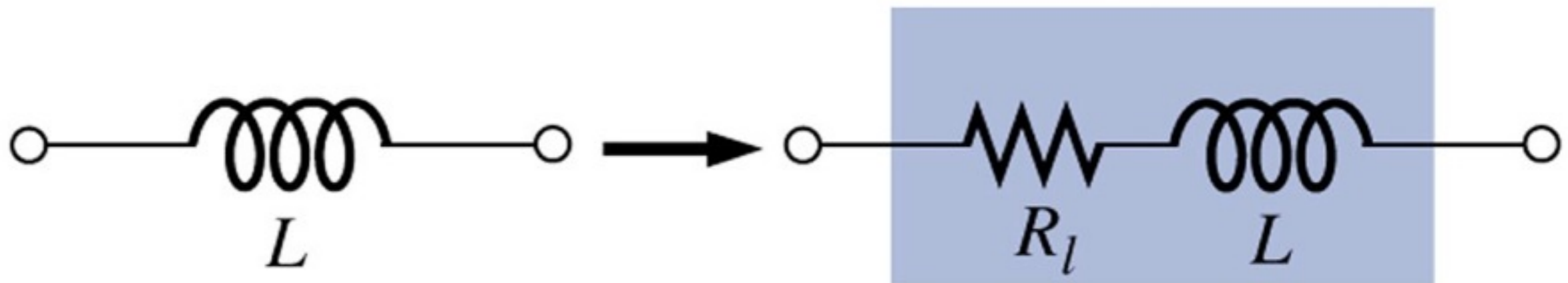


# Entreferros

Espaço sem núcleo nos circuitos magnéticos:



# Circuito Equivalente de Um Indutor



Circuito equivalente prático de um indutor

## Conversores cc-cc:

- Projeto de elementos magnéticos.

