

Centro Federal de Educação Tecnológica de Santa Catarina
Departamento Acadêmico de Eletrônica
Retificadores

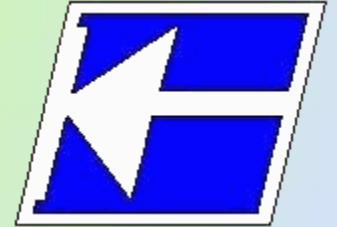

Aplicações dos diodos
Parte 2

Prof. Clóvis Antônio Petry.

Florianópolis, outubro de 2008.

Bibliografia para esta aula

Seqüência de conteúdos:

1. Aplicações de diodos – Parte 2.

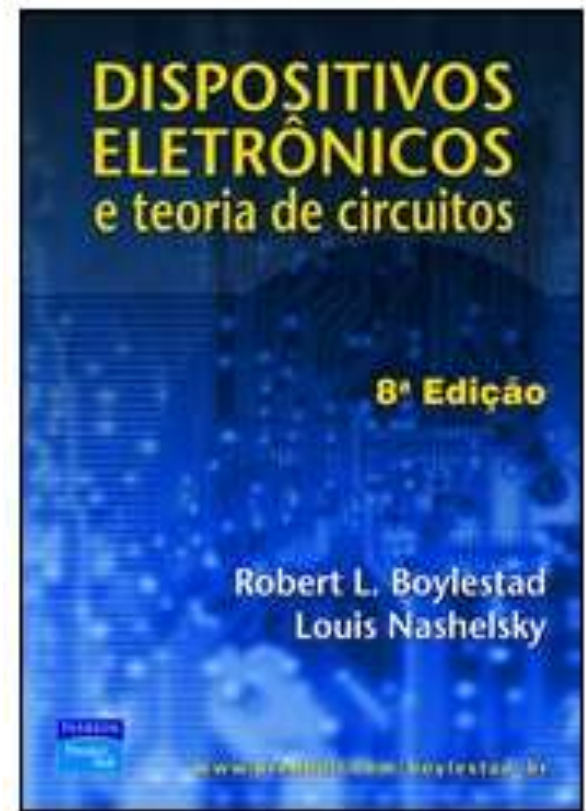

Nesta aula

Seqüência de conteúdos:

1. Portas lógicas com diodos;
2. Retificador de meia onda;
3. Ceifadores;
4. Grampeadores.

Circuitos paralelo de diodos - Resolução

Exemplo 2.15: Determinar as correntes I_1 , I_2 e I_{D2} .

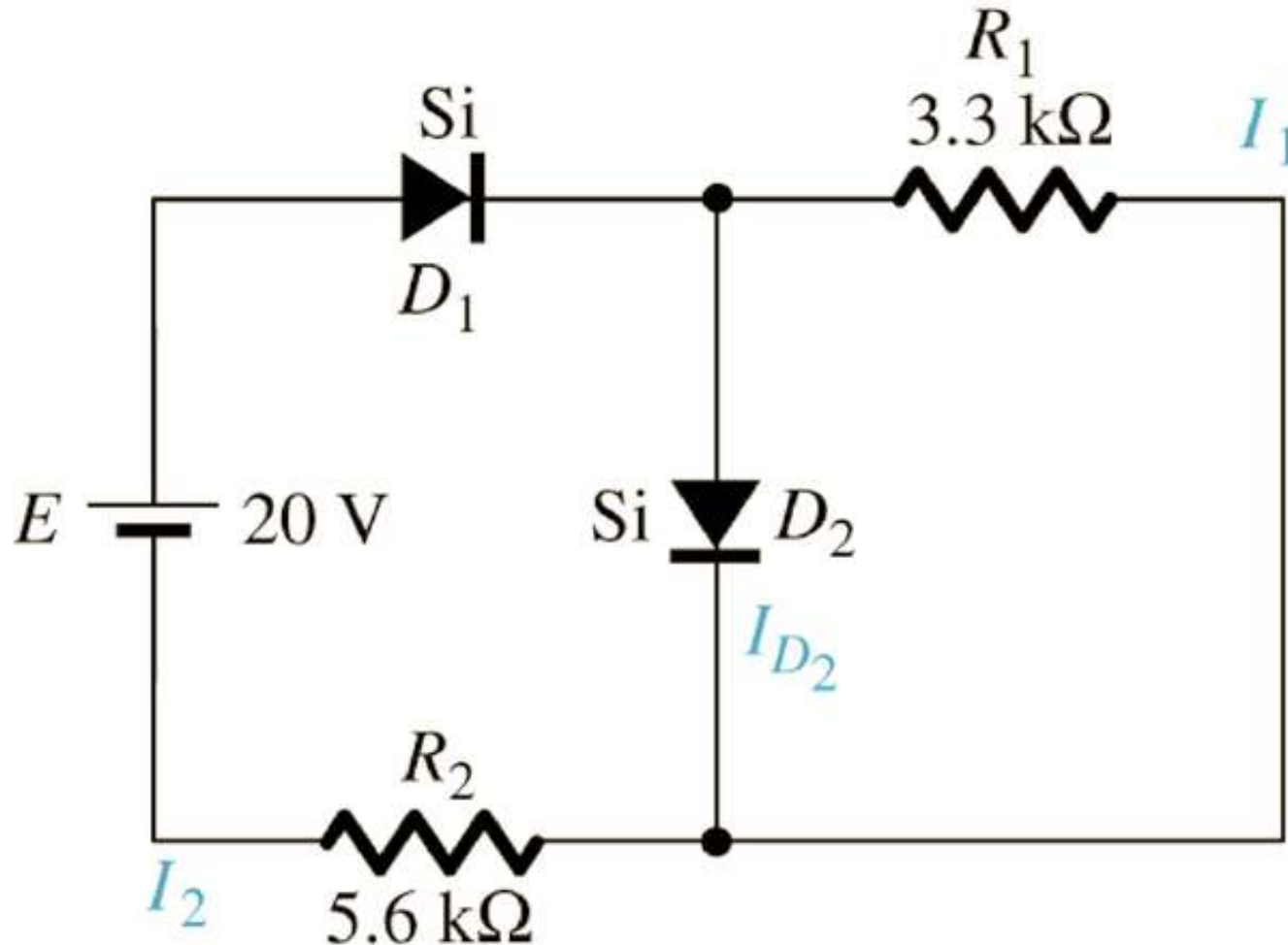

Portas lógicas com diodos

Porta OU (OR):

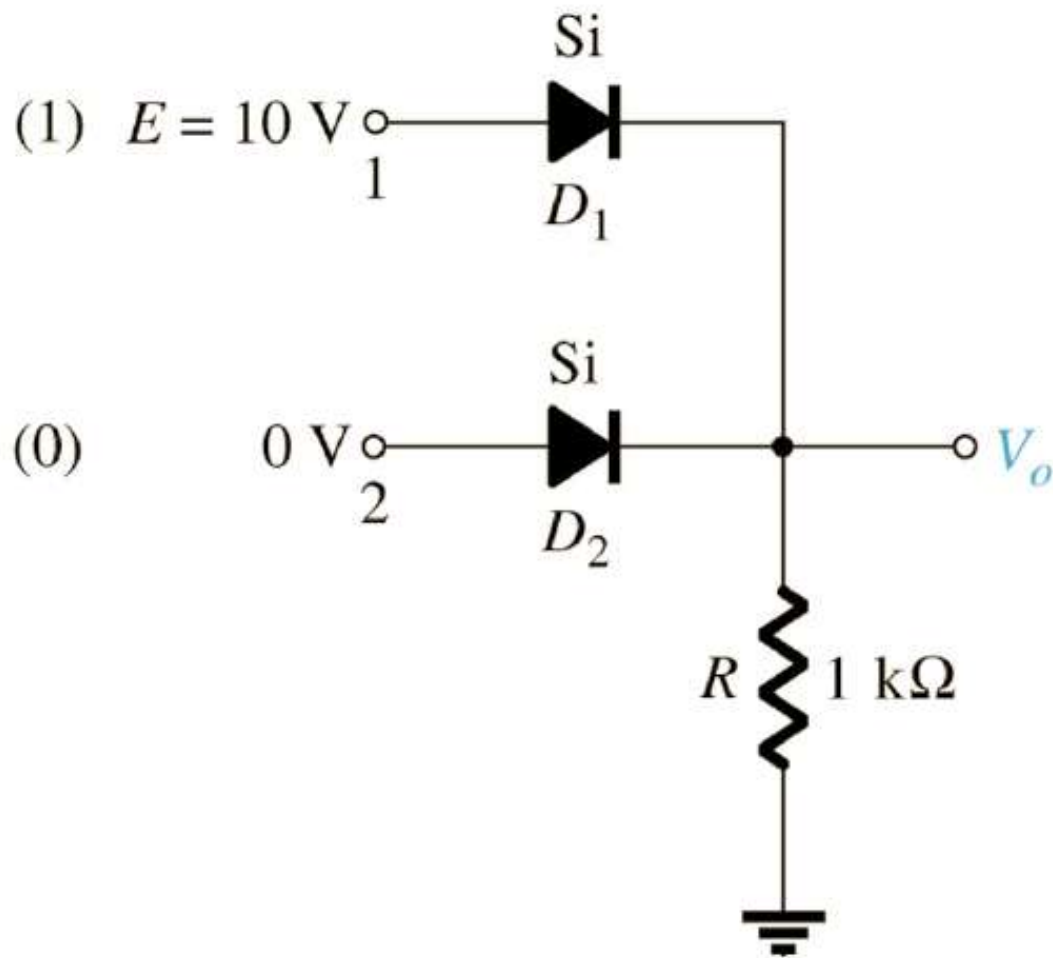

Portas lógicas com diodos

Porta E (AND):

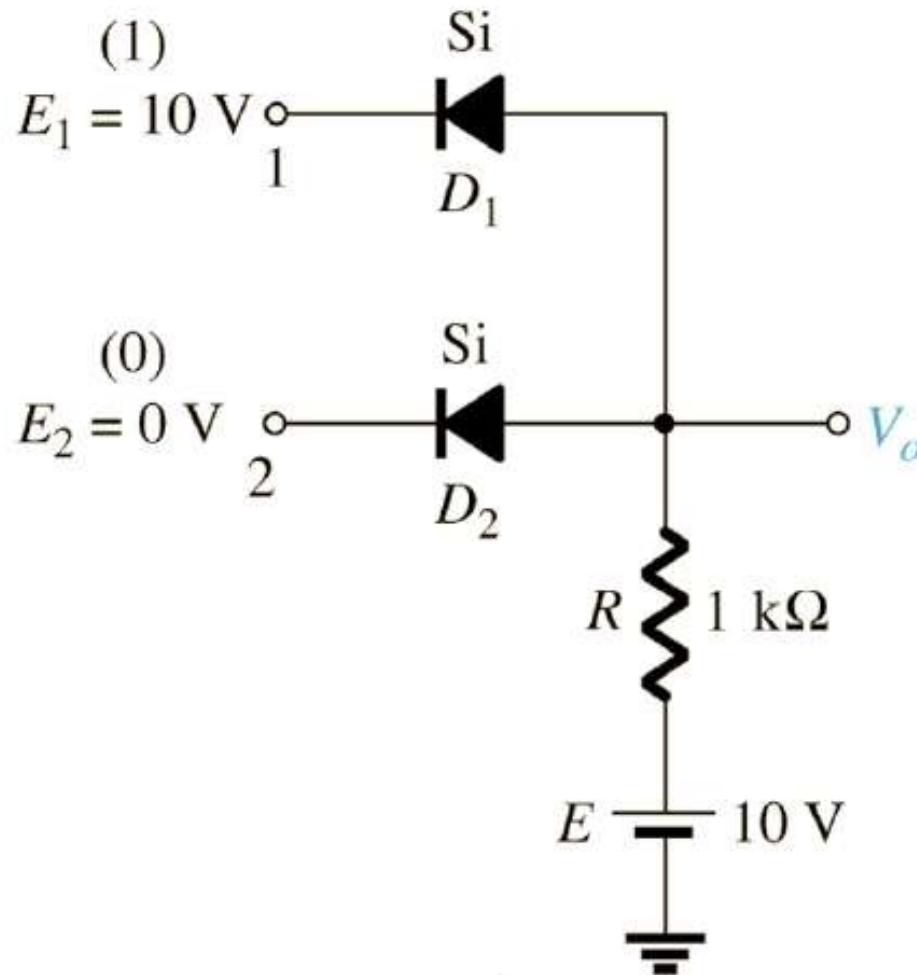

Retificadores

Retificador de meia onda:

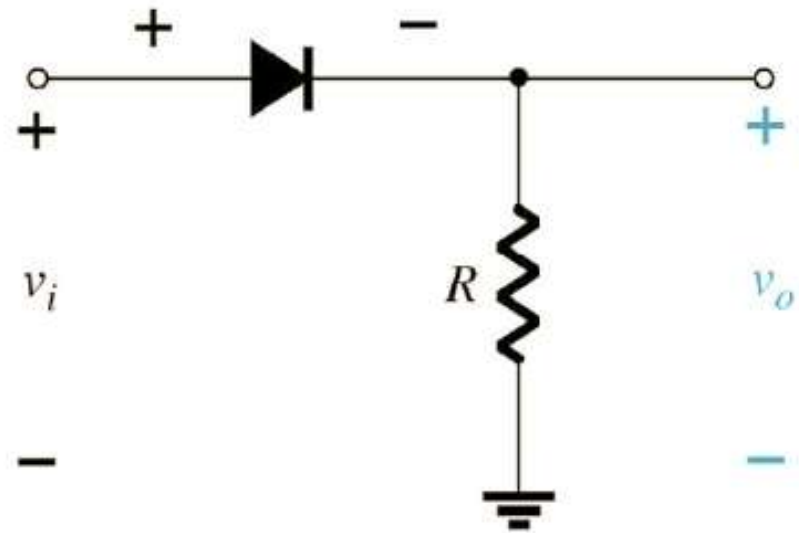
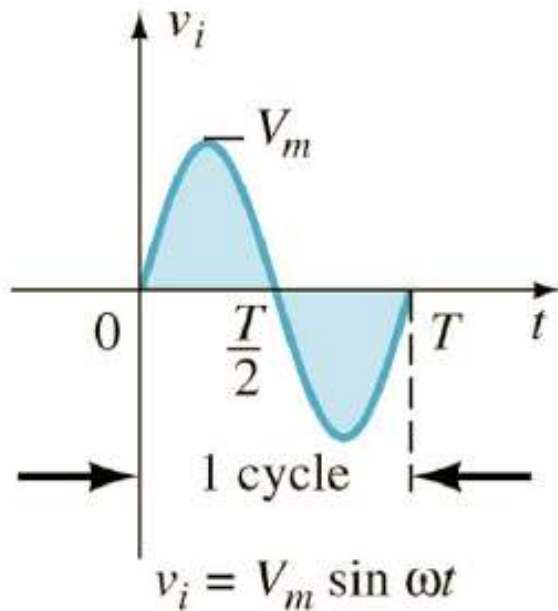

Os circuitos retificadores serão estudados em detalhe em outro momento desta disciplina.

Retificadores

Retificador de meia onda:

Diodo conduzindo.

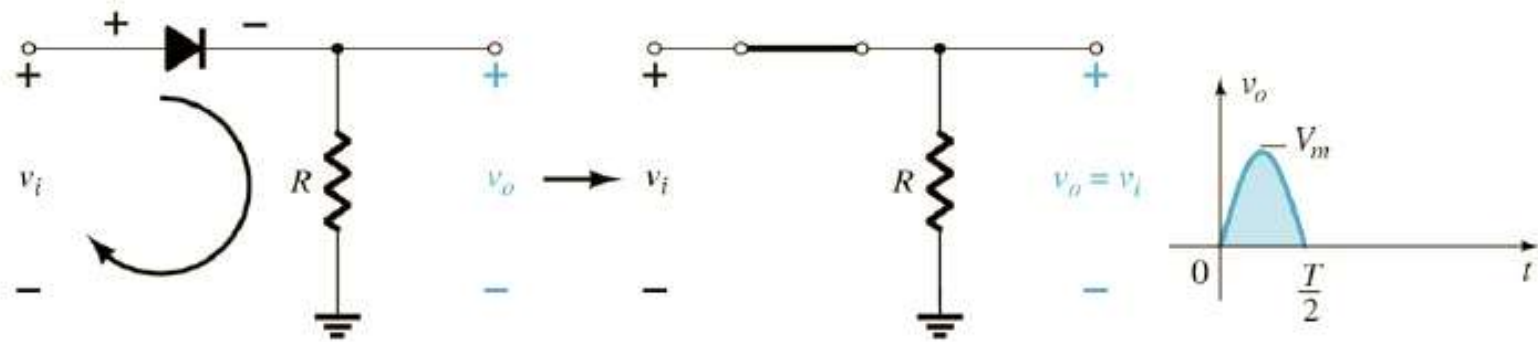

Diodo bloqueado.

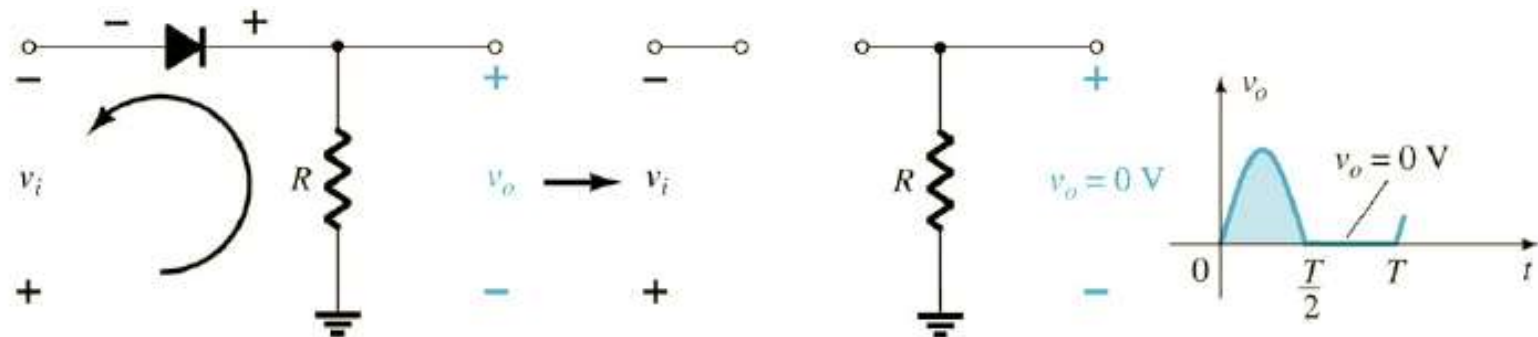

Retificadores

Retificador de meia onda:

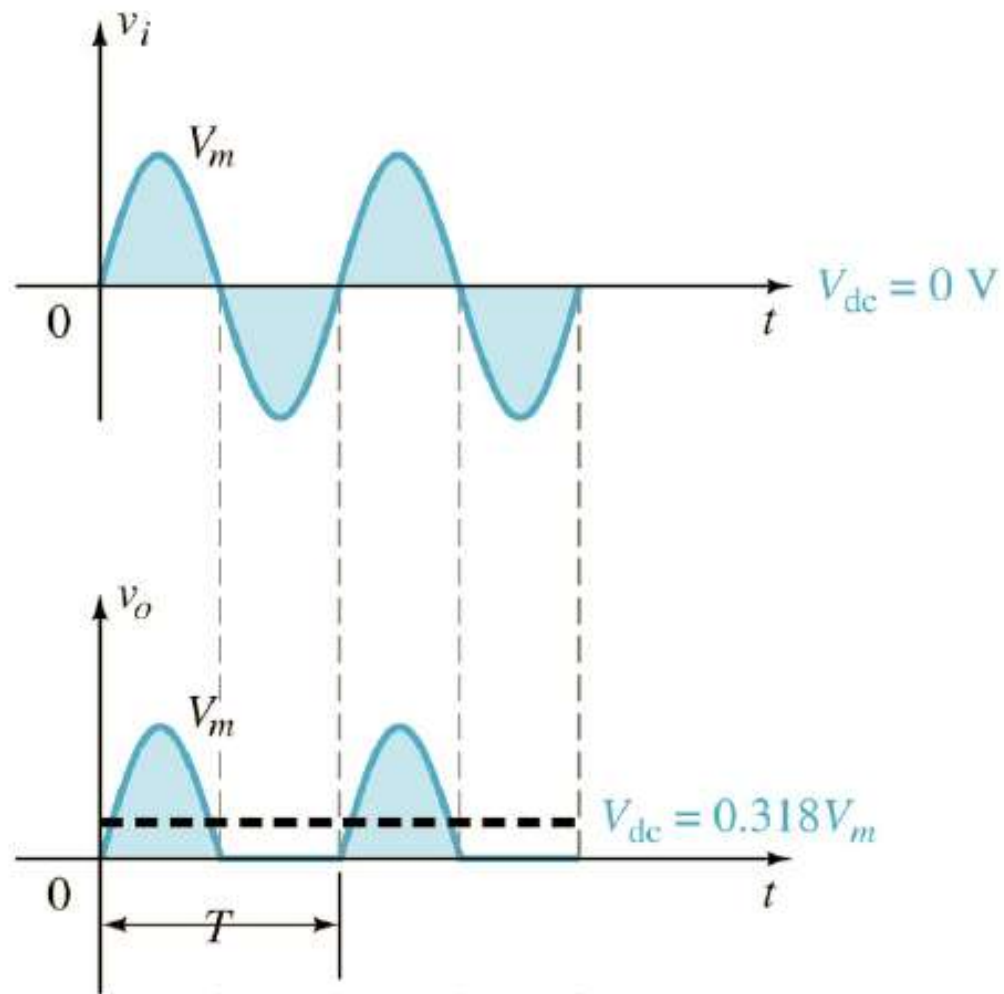

Retificadores

Retificador de meia onda:

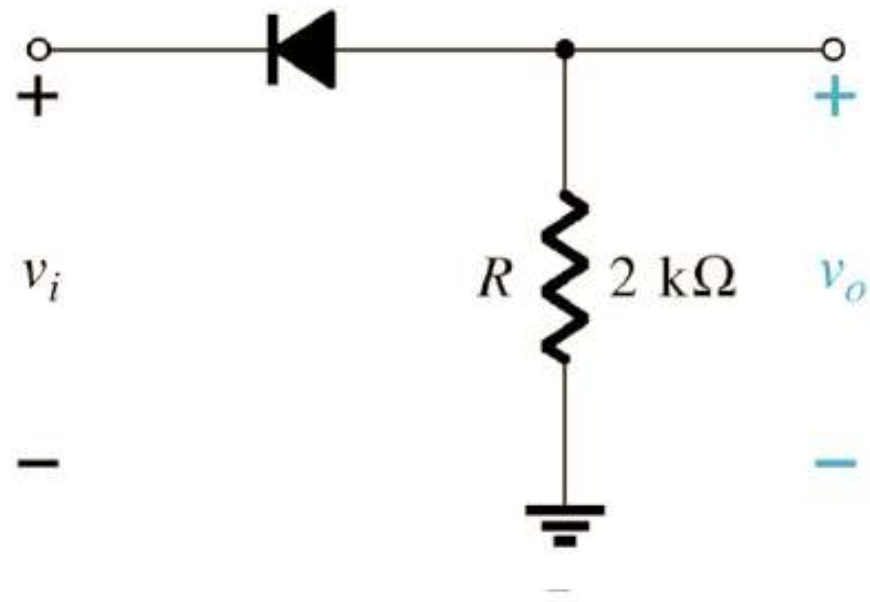
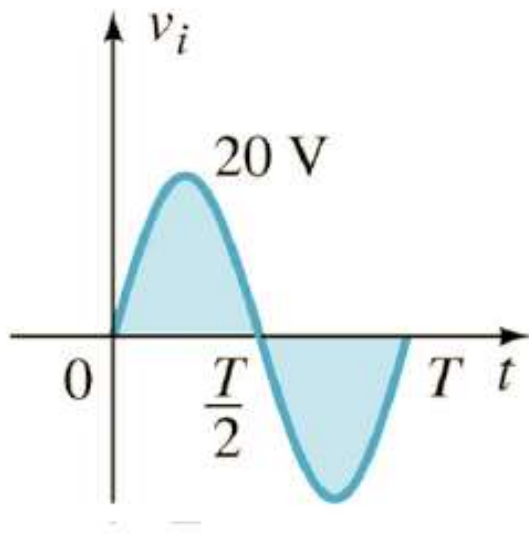

Esboçar a forma de onda da tensão de saída.

Retificadores

Retificadores de onda completa:

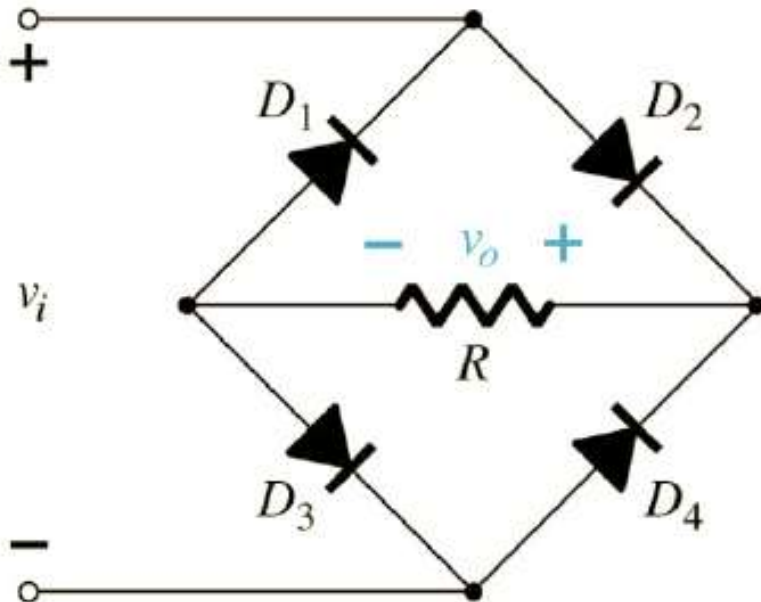

Em ponte.

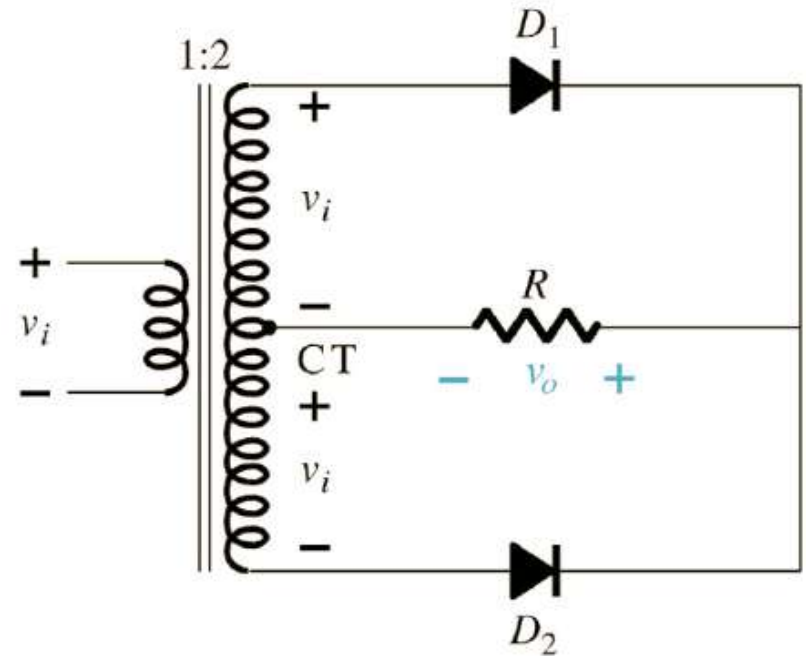

Com transformador em derivação central (tap central).

Ceifadores

Circuitos ceifadores:

- Tem a capacidade de ceifar (cortar) uma parte do sinal;
- Podem ser em série ou em paralelo.

Ceifador série

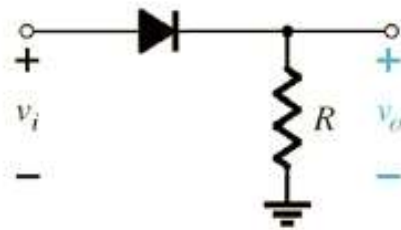

(a)

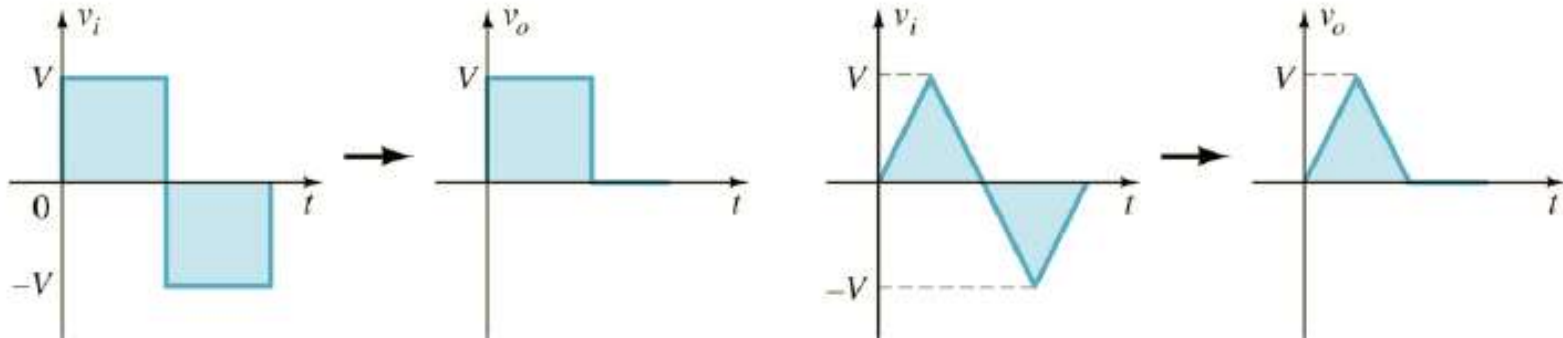

(b)

Ceifadores

Ceifador série com fonte:

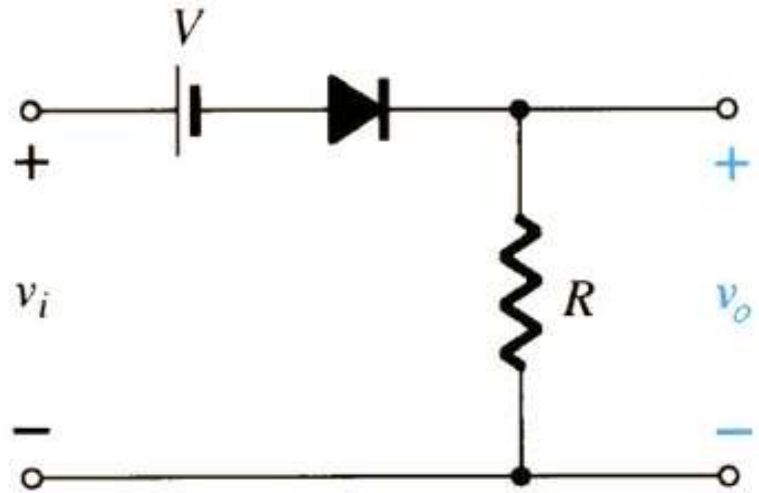
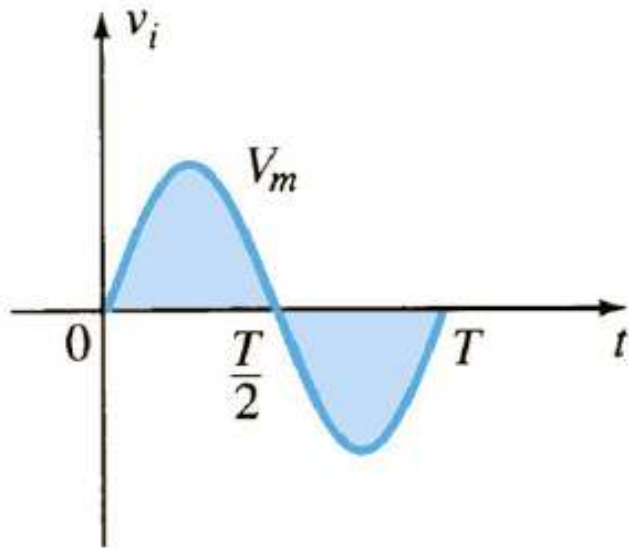

Ceifadores

Ceifador série com fonte, exemplo:

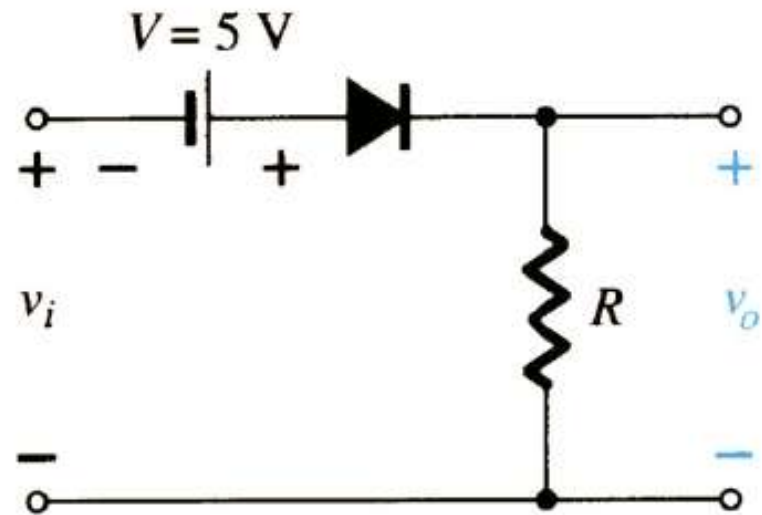
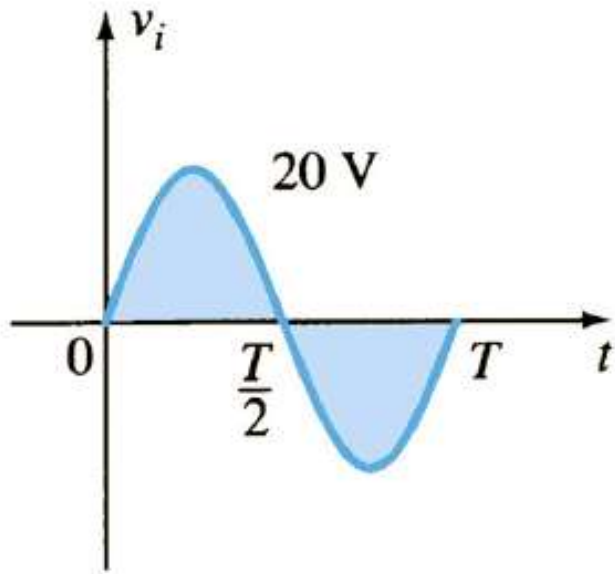

Ceifadores

Ceifador série com fonte, exemplo:

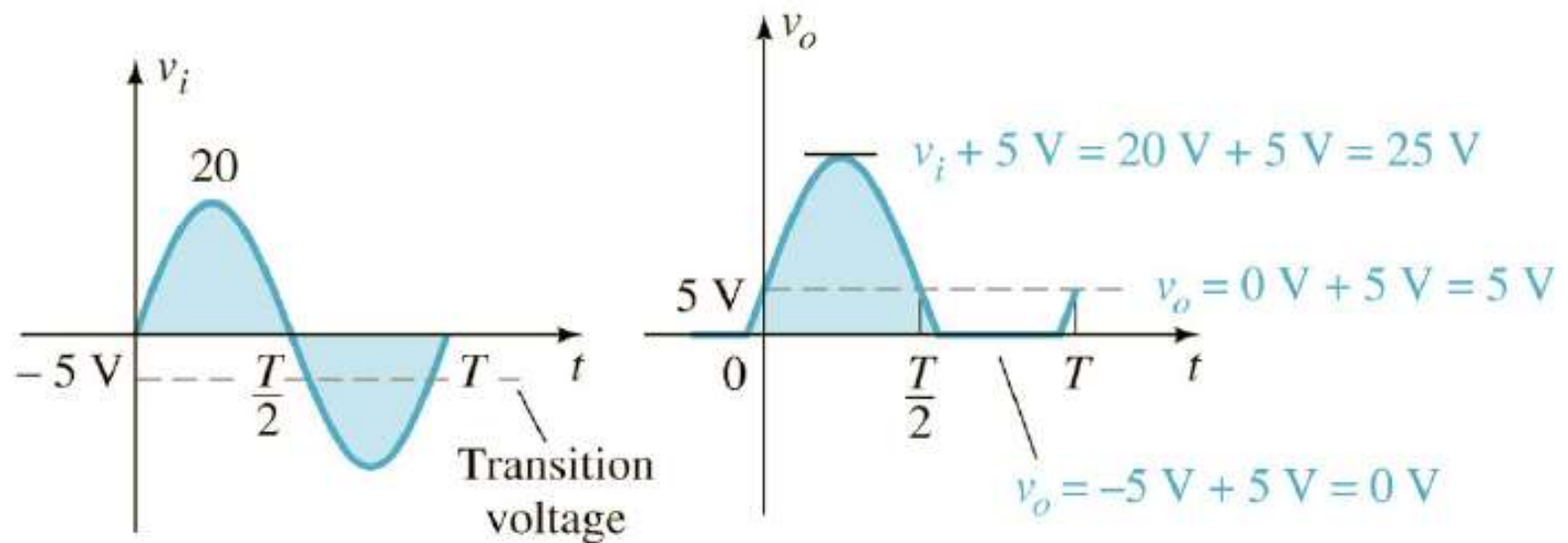

Ceifadores

Ceifador paralelo

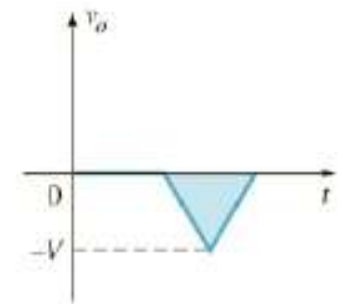
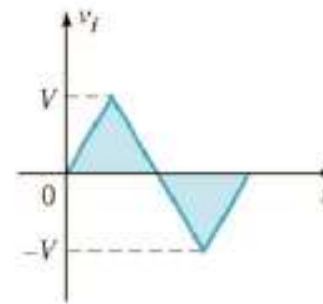
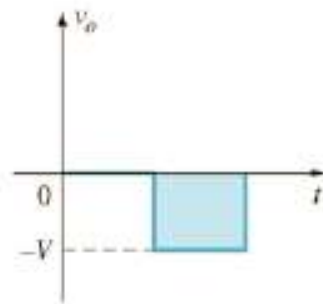
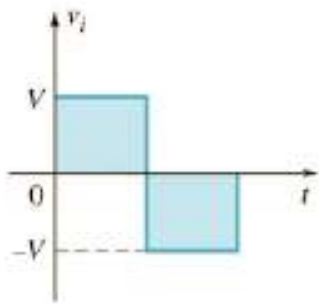
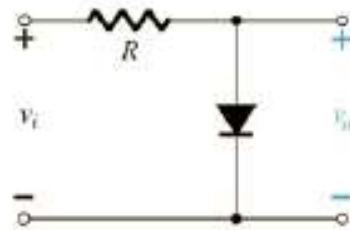

Ceifadores

Ceifador paralelo com fonte, exemplo:

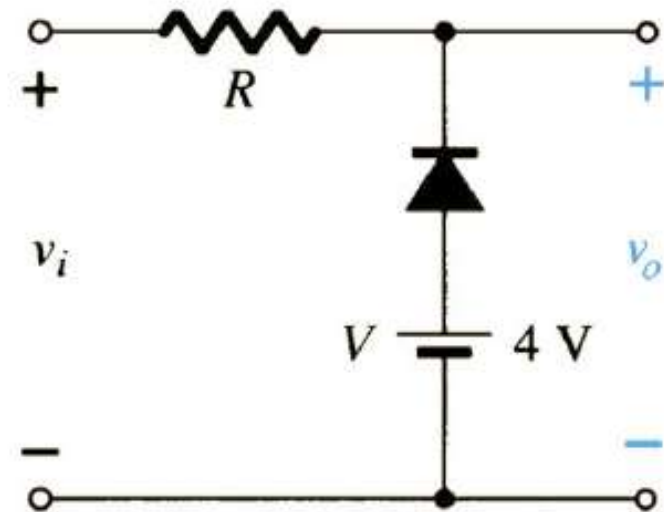
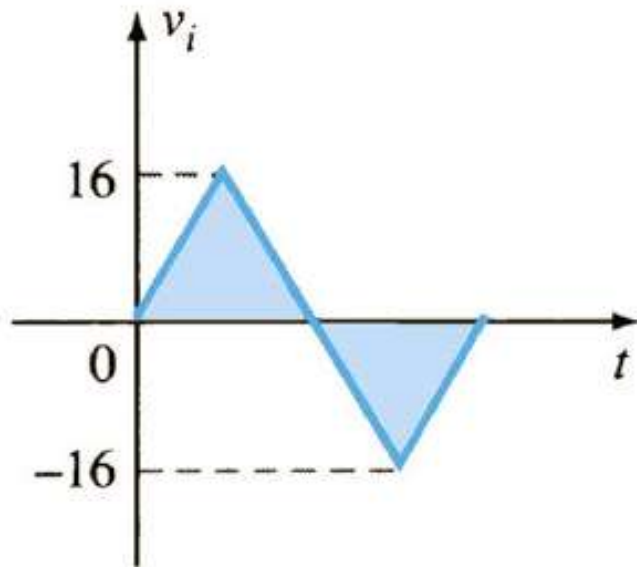

Ceifadores

Ceifador paralelo com fonte, exemplo:

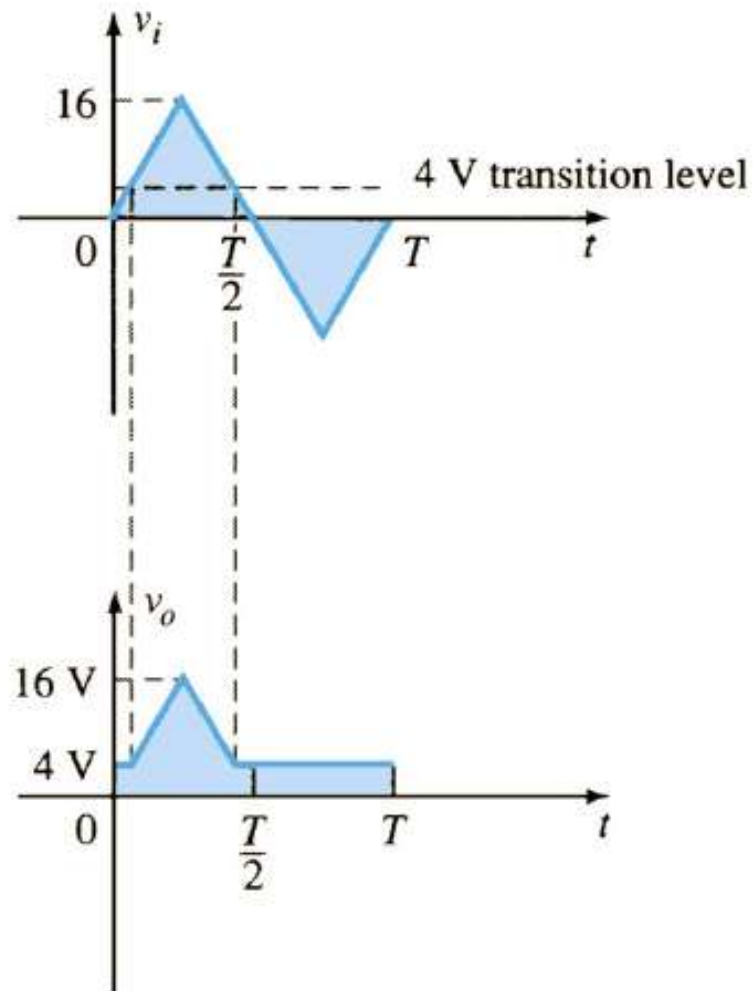

Ceifadores

Simple Series Clippers (Ideal Diodes)

POSITIVE

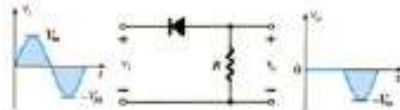

NEGATIVE

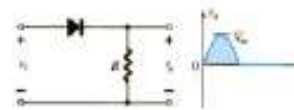

Biased Series Clippers (Ideal Diodes)

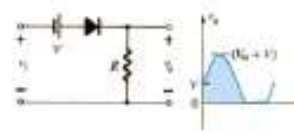
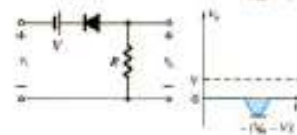
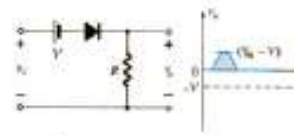

Simple Parallel Clippers (Ideal Diodes)

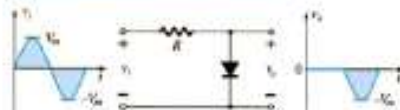

Biased Parallel Clippers (Ideal Diodes)

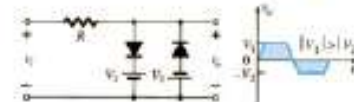
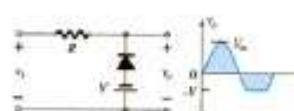

Grampeadores

Circuitos grampeadores:

- Tem a capacidade de grampear um sinal em um valor cc diferente.

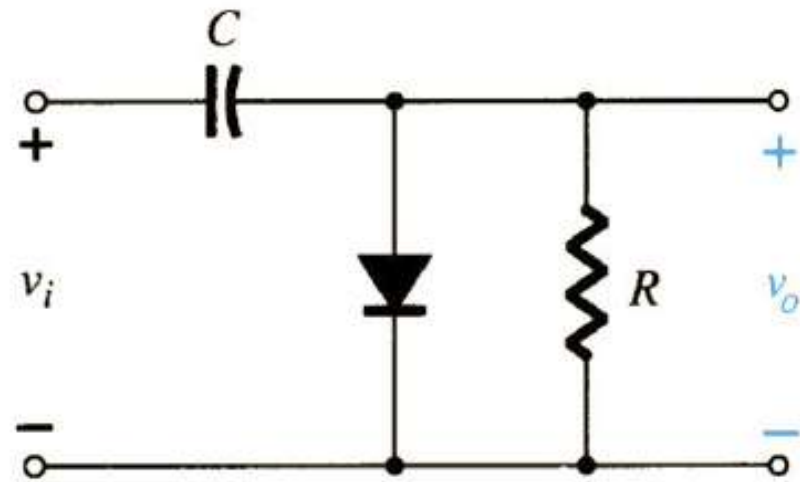
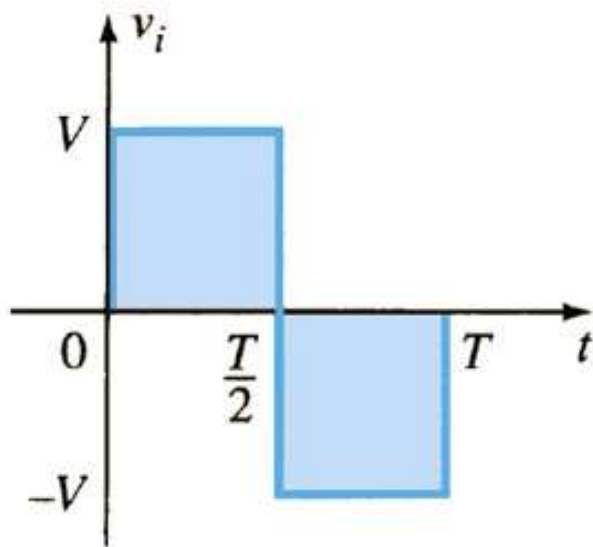

Grampeadores

Diodo em condução:

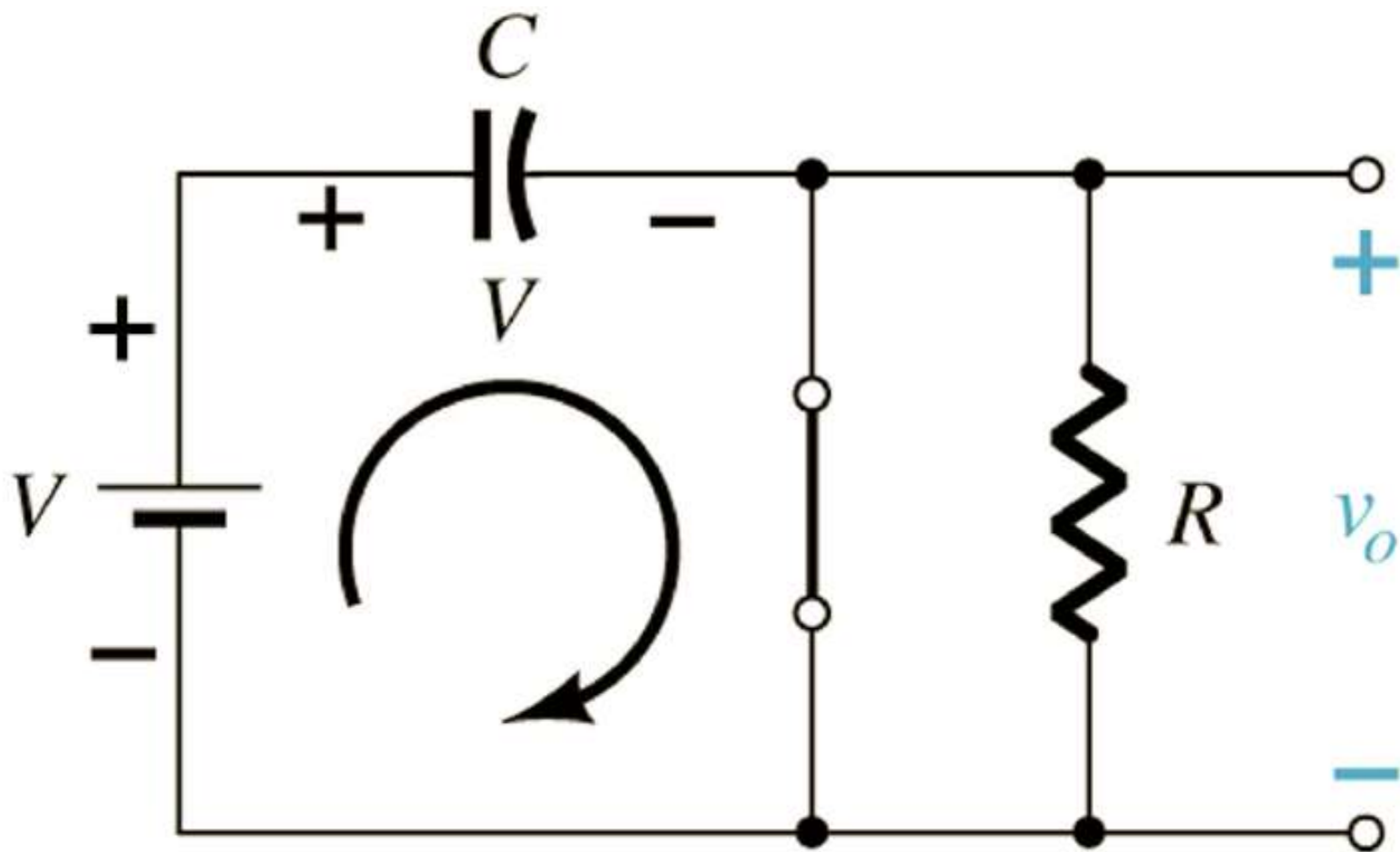

Grampeadores

Diodo bloqueado:

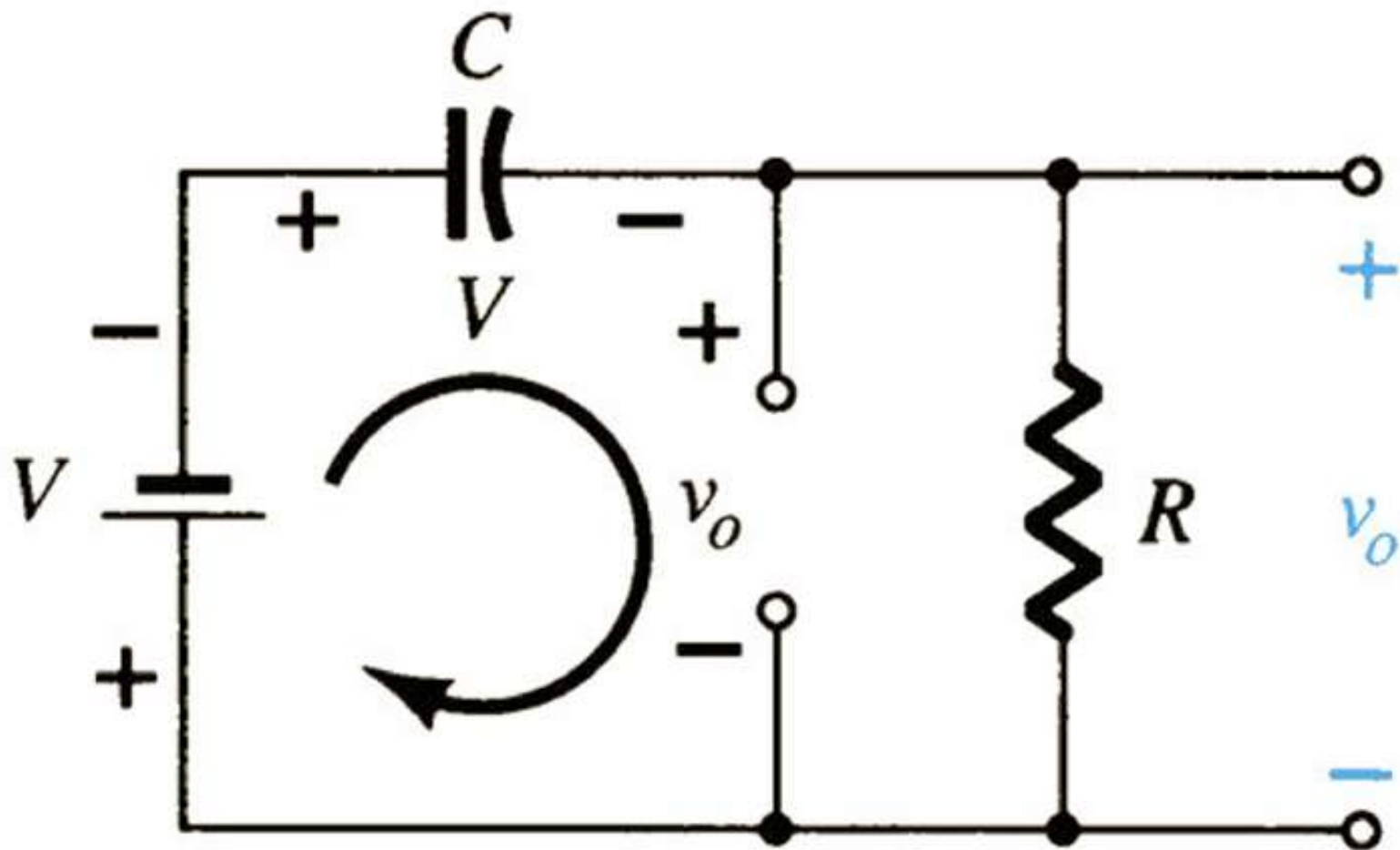

Grampeadores

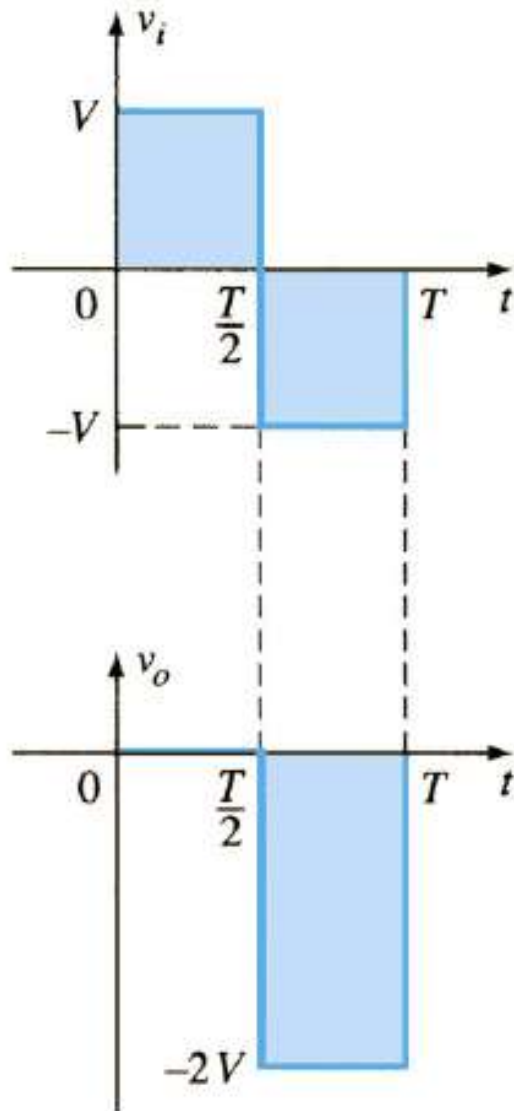

A excursão total da saída é igual à excursão total do sinal na entrada.

Grampeadores – alguns circuitos

Clamping Networks

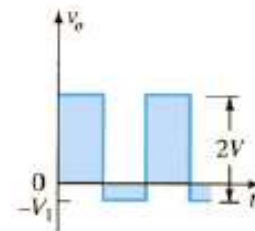
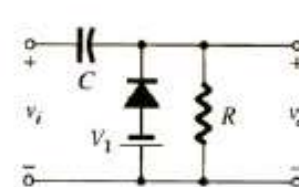
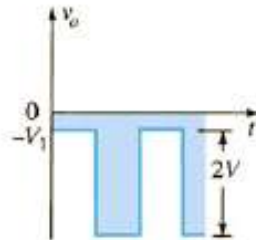
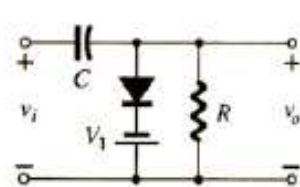
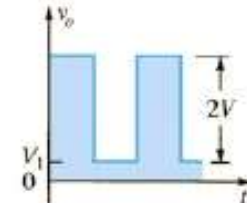
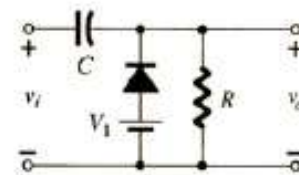
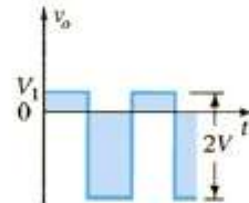
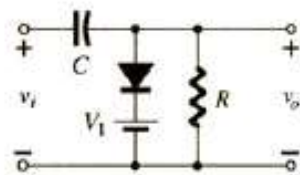
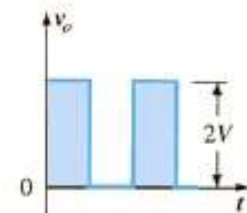
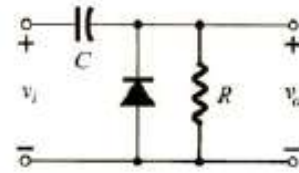
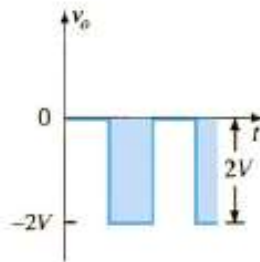
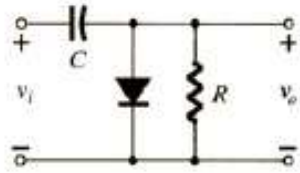
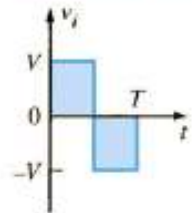

Na próxima aula

Seqüência de conteúdos:

1. Aplicações de diodos – Parte 3.



www.cefetsc.edu.br/~petry